



Precise surveying and measuring



**MEASURING TOOLS**

**LASERS AND ACCESSORIES**

**BUILDERS' LEVELS AND THEODOLITES**

**TRIPODS**

**SURVEYING EQUIPMENT**



**CATALOGUE  
2014/2015**



## **NEDO: THE COMPANY**

---

## Measuring equipment made in Dornstetten

For more than 110 years the Nedo brand has stood for intelligent measuring equipment of outstanding quality, made in Dornstetten.

Surveying engineers and construction professionals in more than 100 countries rely on Nedo products every day to perform a wide range of measuring tasks. Professionals in the building trades value our products for their quality, reliability and sturdiness. Our sales partners appreciate our commitment to customers, on-time deliveries and excellent service.

We maintain long-term cooperation agreements with sales partners in Germany and abroad. Nedo products are sold via a global network of qualified distributors. Customers in North America are supplied via our logistics center and sales office in Kentucky, USA.

Although we do business throughout the world, we are still an owner-managed family company with strong roots in Dornstetten and the Black Forest. For four generations, Nedo and its owners, the Fischer family, have stood for fairness, reliability and a focus on customers.



Dipl.- Wirtschafts-Ing. Frank Fischer  
President

Dr. Ing. Thomas Fischer  
President



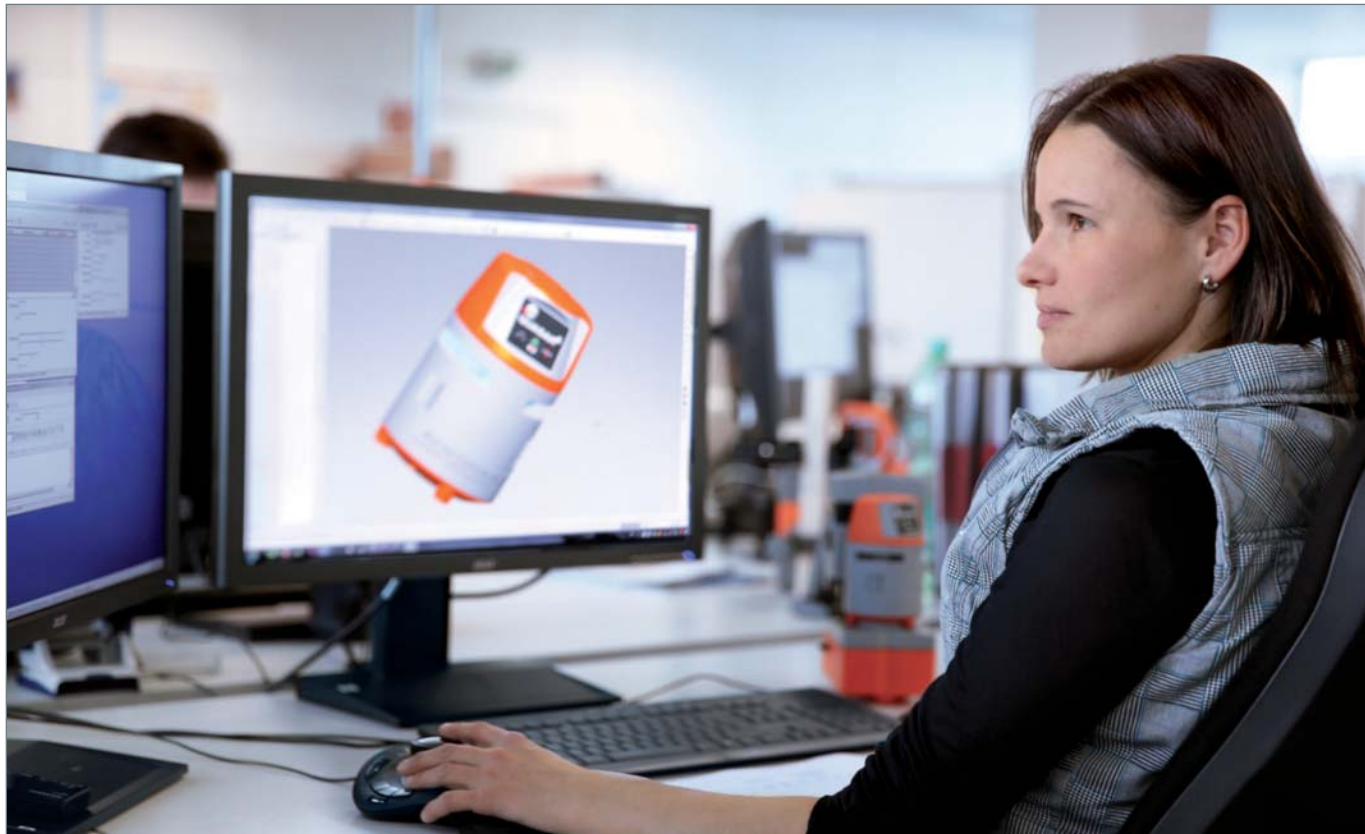

## Engineering expertise

The path from idea to production-ready product is often long and difficult. From the initial design to final testing, critical craftsmen and surveying engineers have to solve a host of problems and develop creative solutions.

At Nedo, product development, toolmaking and production are closely interlinked. This allows us to lay the groundwork for efficient manufacturing already in the development phase. And by developing our products with the manufacturing process in mind, we are able to ensure consistently high quality.

In product development we give top priority to simple and intuitive handling, reliable operation under harsh conditions and functional design. Our developers and engineers have won a number of prizes for excellent design, including the **Red Dot Design Award** and the **Baden-Württemberg International Design Prize**. They are proud of their achievements and determined to maintain these standards in the future.

We will gladly make our expertise available to customers who would like us to develop special products.



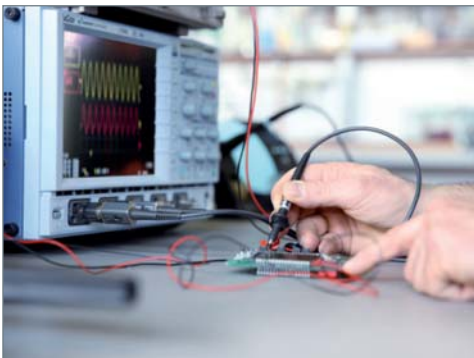

## Manufacturing know-how

Nedo manufactures high-tech products at plants in Dornstetten and Switzerland. Its highly motivated employees receive continuous further training and use state-of-the-art technology.

Our corporate culture emphasises optimally structured production processes, efficient logistics and an uncompromising commitment to quality. Needless to say, Nedo's quality management system is certified to DIN EN ISO 9001:2008.

Instead of relocating our production to low-wage countries, we have made substantial investments in our plants in Germany and Switzerland, and we have continuously improved the competitiveness of our production locations through rigorous cost management. Thanks to our large vertical range of manufacture we are independent of suppliers to a high degree. Production processes which are critical to product quality are kept under the direct control of our employees rather than being outsourced to other companies.

For our customers this means highly reliable products, strict adherence to delivery deadlines and flexibility when it comes to fulfilling special requests.



## 08

### MEASURING TOOLS

- 10 mEssfix
- 17 Telemeter
- 18 mEsstronic
- 22 *laser* mEssfix<sup>80</sup>
- 24 Leica DISTO
- 26 Winkelfix
- 27 Winkeltronic
- 29 Inclinometer Level

## 30

### LASERS/ACCESSORIES

- 32 Line lasers at a glance
- 34 X-Liner
- 44 QUASAR
- 52 Rotating lasers at a glance
- 54 SIRIUS
- 60 PRIMUS
- 70 TUBUS
- 72 Laser receiver
- 74 Accessories
- 80 Laser Calibration

## 84

### BUILDERS' LEVELS/ THEODOLITES

- 88 Builders' Levels F-series
- 89 Builders' Levels X-series
- 90 Builders' Levels Z-series
- 91 Electronic Theodolite ET-5



# CONTENTS

## 91

### TRIPODS

- 95 Aluminium Tripods
- 98 Telescopic and Elevating Tripods
- 103 Tripods for machine control applications
- 104 Industrial Line Tripods
- 107 Wooden Tripods
- 110 Ceiling Monopod
- 111 Accessories

## 114

### SURVEYING EQUIPMENT

- 116 Telescopic Levelling Staffs
- 126 Circular Bubbles, Staff Levels and Folding Levelling Rules
- 128 EDM Accessories
- 130 Prism Poles
- 132 Prism Pole Accessories
- 134 Adapters for Prisms
- 135 Measuring Wheels
- 138 Ranging Poles
- 140 Ranging Pole Supports
- 141 Surveying Accessories





## MEASURING TOOLS

---

## Precise Measurement of Lengths and Angles

Nedo measuring tools provide innovative solutions for precise measurement of lengths and angles in interior finishing.

In addition, Nedo manufactures special measuring tools for axle alignment and measurement of vehicle body parts.

**Nedo's mEssfix** is the classic product in its line of measuring tools. This telescopic rule with an integrated analogue display is ideal for quick and precise measurement of clear dimensions, as thousands of users have discovered. It is indispensable in window making and many other areas of interior finishing.

The new **laser mEssfix<sup>80</sup>** is the **mEssfix** among the laser distance measuring instruments: robust, reliable and accurate.

**Winkelfix** and **Winkeltronic** measure and transfer angles of all kinds, quickly and precisely. They are essential in carpentry, cabinet making, structural steel work and the construction of kitchens and staircases.

Nedo **inclinometer levels** are used in interior finishing, horticulture and landscaping.

---





**Nedo mEssfix-  
the original**



## Nedo mEssfix

The Nedo **mEssfix** is a thoroughly tried-and-tested telescopic measuring stick, designed to measure the widths of openings. Nedo **mEssfix** - the original. Simply place the **mEssfix** in position, pull out the extensions and read off the measurement from the analogue display. A two-way spirit level attached to the outer tube facilitates taking vertical and horizontal measurements. The built-in metal measuring tape and the heavy-duty rewind mechanism are made to withstand severe stresses and to guarantee accurate measurements at all times. Thanks to its ease of use, reliability and sturdiness, the Nedo **mEssfix** has become indispensable in most skilled trades, such as in window frame making or interior outfitting.

### Features:

- Rugged telescopic measuring stick
- Housing made of impact-resistant plastic
- Bubble for horizontal and vertical alignment
- Sections made of sturdy, rectangular-profile aluminium
- Made in Switzerland





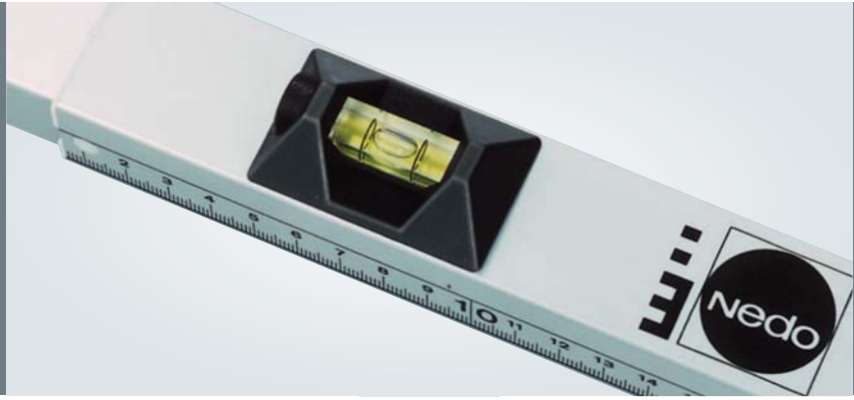

## Nedo mEssfix

Ref.-No.	Measuring range	Length retracted	Graduations	Weight
F 180 111	0.37 to 1.00 m	0.37 m	mm	0.7 kg
F 180 113	0.37 to 1.00 m / 15" to 39"	0.37 m / 15"	mm/inch	0.7 kg
F 280 111	0.53 to 2.00 m	0.53 m	mm	0.9 kg
F 280 113	0.53 to 2.00 m / 21" to 78"	0.53 m / 21"	mm/inch	0.9 kg
F 380 112	0.70 to 3.00 m	0.70 m	mm	1.1 kg
F 380 113	0.70 to 3.00 m / 28" to 118"	0.70 m / 28"	mm/inch	1.1 kg
F 480 111	0.86 to 4.00 m	0.86 m	mm	1.4 kg
F 480 113	0.86 to 4.00 m / 34" to 157"	0.86 m / 35"	mm/inch	1.4 kg
F 580 111*	1.07 to 5.00 m	1.07 m	mm	1.7 kg
F 580 115*	1.07 to 5.00 m / 43" to 196"	1.07 m / 43"	mm/inch	1.7 kg

## Nedo mEssfix with Points for Roller Shutter Constructors

Ref.-No.	Measuring range	Length retracted	Graduations	Weight
F 181 111	0.47 to 1.10 m	0.47 m	mm	0.8 kg
F 281 111	0.63 to 2.10 m	0.63 m	mm	1.0 kg
F 381 111	0.80 to 3.10 m	0.80 m	mm	1.2 kg
F 481 111	0.96 to 4.10 m	0.96 m	mm	1.4 kg
F 581 111*	1.17 to 5.10 m	1.17 m	mm	1.8 kg

## Cases for Nedo mEssfix

Ref.-No.	Type	For model Ref.-No.	Ref.-No.	Type	For model Ref.-No.
190 111	Case	F 180 111 / F 180 113	291 111	Case	F 281 111
290 111	Case	F 280 111 / F 280 113	391 111	Case	F 381 111
390 121-613	Case	F 380 112 / F 380 113	491 111	Case	F 481 111
490 121-613	Case	F 480 111 / F 480 113			

\* Supplied with case as a standard.

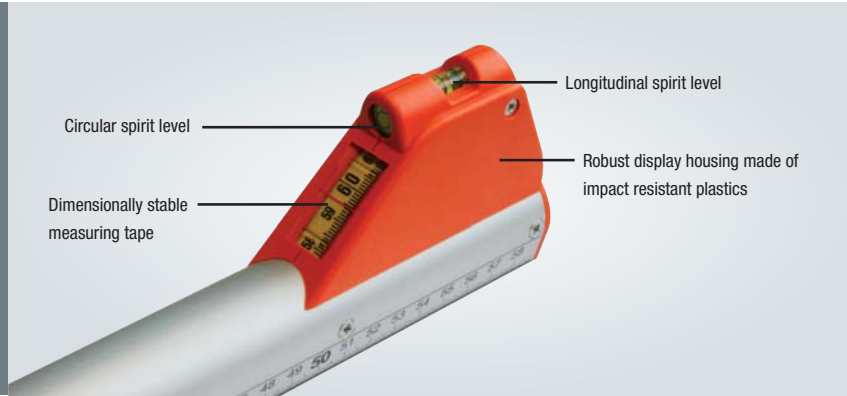

## Nedo mEssfix *compact*

The lightweight and handy telescopic measuring stick **mEssfix compact** is an aggressively priced alternative to the **mEssfix**. It is designed to measure interior dimensions quickly, reliably and with the utmost ease. Simply place the **mEssfix compact** in position, pull out the extensions and conveniently read off the measurement from the analogue display. Ideal in interior outfitting.

Nedo **mEssfix compact** is very handy thanks to its compact dimensions, its light weight and its round telescopic tubes.

The display is attached at the foot of the **mEssfix compact**, so when measuring windows, the measured values can conveniently be read off at eye level. A two-way bubble is integrated into the display housing to facilitate taking horizontal and vertical measurements.

### Features:

- Compact dimensions
- Robust display housing with horizontal/vertical bubbles
- Circular telescopic tubes for convenient handling
- Supplied with case as a standard



### Nedo mEssfix *compact*

Ref.-No.	Measuring range	Length retracted	Graduations	Weight
F 380 211	0.60 to 3.04 m	0.60 m	mm	0.9 kg
F 580 211	0.91 to 5.01 m	0.91 m	mm	1.4 kg

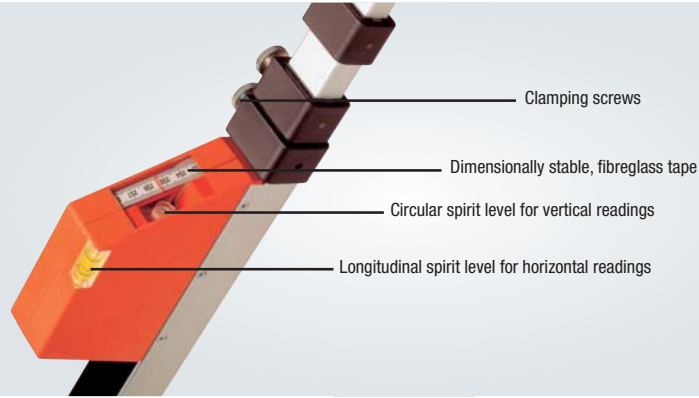

## Nedo mEssfix-S

With a measuring range of up to 8 m the **mEssfix-S** is the ideal helper on the construction site, e.g. for work on scaffolding, for measurements of facades or for the determination of clearances. The display is attached on the upper end of the rod which allows for a convenient read-off.

### Features:

- Measuring ranges: 5 m, 6 m and 8 m
- Display unit contains two integral spirit levels, conveniently placed at eye level
- Circular spirit level for vertical alignment
- Longitudinal spirit level for horizontal alignment
- Tape winding spring made of best quality spring steel
- Telescopic sections made of sturdy, rectangular-profile aluminium
- Clamping screws allow extending sections to be locked in any position



### Nedo mEssfix-S

Ref.-No.	Measuring range	Length retracted	Graduations	Weight
F 580 151	1.03 to 5.00 m	1.03 m	mm/cm	2.0 kg
F 680 151	1.20 to 6.00 m	1.20 m	mm/cm	2.4 kg
F 880 151	1.53 to 8.00 m	1.53 m	mm/cm	2.6 kg

### Cases for Nedo mEssfix-S

Ref.-No.	Type	For model Ref.-No.
590 151	Case	F 580 151
690 151	Case	F 680 151
890 151	Case	F 880 151



## Nedo Auto-mEssfix

The Nedo **Auto-mEssfix** is the telescopic gauge for quick checking and measurement of deformed or already restraightened vehicle body parts. Ideal for assessing the extent of damage, measuring structural damage or for checking of dimensions after restraightening. You simply pull out the extending sections and read off the distance between two measurement points from the analogue display. Quick, reliable and precise.

Choose from three sturdy models. The two larger models are fitted with clamping screws for fixing the extendable tubes; this prevents inadvertent displacement of the settings.



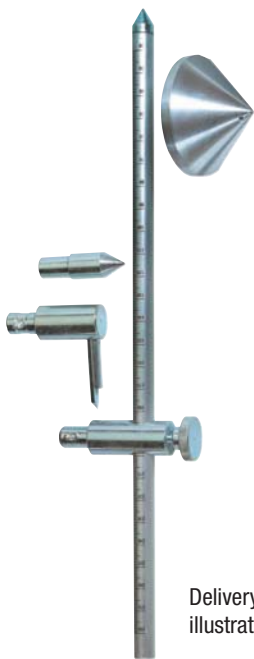

Measurements in almost inaccessible places can be made with the aid of spikes which are supplied as a standard. Distances between two points lying in different planes are determined rapidly and easily. The delivery also includes measuring cones that allow for measurements of intervals between holes.

Delivery includes two of each of the illustrated measuring accessories.

### Nedo Auto-mEssfix

Ref.-No.	Measuring range	Length retracted	Graduation	Weight
F 281 119	415 to 945 mm	415 mm	mm	1.3 kg
F 281 219	920 to 2610 mm	920 mm	mm	1.8 kg
F 281 319	950 to 3260 mm	950 mm	mm	2.0 kg

### Case for Nedo Auto-mEssfix

Ref.-No.	Type	For model Ref.-No.
281 375	Wooden case	Suitable for all Auto-mEssfix models



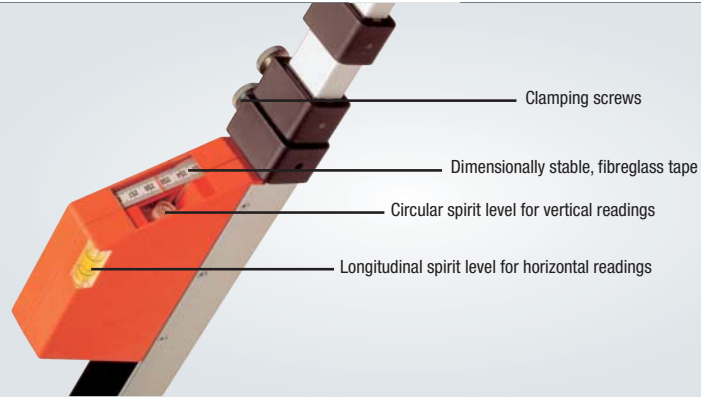

## Nedo Truck & Trailer mEssfix

The telescopic rule to conveniently measure the height of trucks, trailers and construction vehicles. The measured values can be easily read off from the analogue display. With removable cross-arm for easy handling and convenient transport. Includes case.

### Features:

- Measuring range: 1.45 m to 5.16 m
- Graduations: mm/cm
- Arm for truck measurement (1.25 m long)
- Supplied with case as a standard



### Nedo Track & Trailer mEssfix

Ref.-No.	Measuring range	Length retracted	Graduations	Weight
687 811	1.45 to 5.16 m	1.45 m	mm/cm	3.0 kg







## Nedo Telemeter

The Nedo **Telemeter** is a practical all-purpose measuring rod for interior and exterior use. It can be used in building work, interior outfitting and the construction of exhibition stands and work on scaffolding.

The 1 m extending sections run between abrasion-resistant plastic guides which also serve as wiper blades. By means of practical pushbuttons, the Nedo **Telemeter** can be reliably locked, thus preventing the telescopic elements from being retracted unintentionally.

### Features:

- Rugged telescopic measuring stick
- Easy handling
- Wear-resistant mm graduations on both sides
- Reliable push-button lock



### Nedo Telemeter

Ref.-No.	Measuring range	Length retracted	Graduations	Weight
F 575 313	1.12 to 5.00 m	1.12 m	mm	1.15 kg

### Cases for Nedo Telemeter

Ref.-No.	Type	For model Ref.-No.
372 111-613	Case	F 575 313

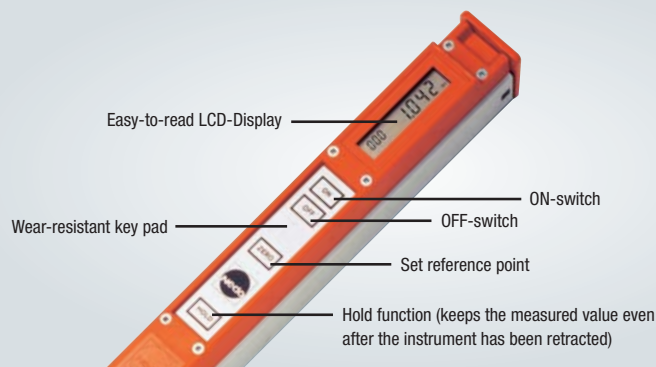

## Nedo mEsstronic Easy

The Nedo **mEsstronic Easy** is an easy-to-use electronic measuring tool for the skilled tradesman. Simply place the **mEsstronic Easy** in position, pull out the extending sections and read off the measurement from the digital display.

The zero function allows to set reference points for relative measurements. Deviations from the reference points are calculated automatically.

The hold button permits the measured value to be retained in the display. In this way, a measurement can be taken in an inaccessible place and then be read off at a more convenient time. The two models with maximum ranges of 3 m and 5 m cover all typical measuring tasks entailed in building operations.



### Features:

- Measuring ranges: 3 m or 5 m
- Reliable Nedo digital technology
- Mechanical components based on proven mEssfix technology
- Power supply: 4 x 1.5 V batteries type (AA) or 4 x 1.2 V rechargeable batteries
- Operation duration: approx. 200 hours (continuous use)
- Automatic switch-off after 3 minutes of non-use
- Zero function: sets reference points for relative measurements
- Hold function: permits use in almost inaccessible places and read-off when convenient

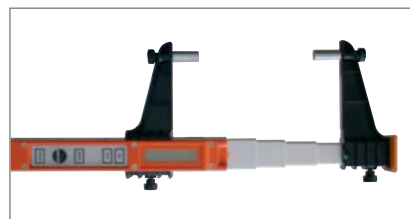

### Measuring Jaws for mEsstronic and mEsstronic Easy

Clip-on **measuring jaws** for easy and convenient measurements of external dimensions.

**Ref.-No. 583 500**

### Nedo mEsstronic Easy

Ref.-No.	Measuring range	Length retracted	Graduations	Resolution	Weight
583 121	0.70 m to 3.00 m	0.70 m	mm	1 mm	1.3 kg
585 121	1.04 m to 5.00 m	1.04 m	mm	1 mm	2.0 kg

### Cases for Nedo mEsstronic Easy

Ref.-No.	Type	For model Ref.-No.
593 111	Case	583 121
595 111	Case	585 121

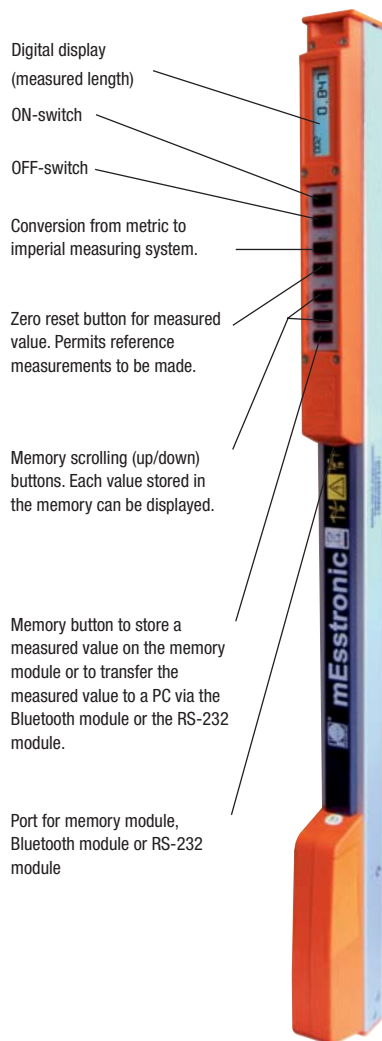

Digital display  
(measured length)

ON-switch

OFF-switch

Conversion from metric to  
imperial measuring system.

Zero reset button for measured  
value. Permits reference  
measurements to be made.

Memory scrolling (up/down)  
buttons. Each value stored in  
the memory can be displayed.

Memory button to store a  
measured value on the memory  
module or to transfer the  
measured value to a PC via the  
Bluetooth module or the RS-232  
module.

Port for memory module,  
Bluetooth module or RS-232  
module

## Nedo mEsstronic

Nedo **mEsstronic** is an electronic measuring tool for the skilled tradesman. In addition to the functions offered by the **mEsstronic Easy**, the mEsstronic is equipped with a port for a memory module, a Bluetooth module or a RS-232 module. Measured values can be stored or transferred to a laptop or to other units with the aid of these modules.

### Features:

- Measuring ranges: 3 m, 5 m and 8 m
- Power supply: 4 x 1.5 V batteries type (AA) or 4 x 1.2 V rechargeable batteries
- Operation duration: approx. 200 hours (continuous use)
- Automatic switch-off after 3 minutes of non-use
- Zero function: sets reference points for relative measurements
- Internal memory for 10 values
- Port for memory module, Bluetooth module and RS-232 module



### Nedo mEsstronic

Ref.-No.	Measuring range	Graduations	Resolution	Weight
583 111	0.70 m to 3.00 m / 28" to 120"	mm/inch	1 mm	1.4 kg
585 111	1.04 m to 5.00 m / 41" to 200"	mm/inch	1 mm	2.1 kg
588 111	1.54 m to 8.00 m / 61" to 320"	mm/inch	1 mm	2.8 kg

### Cases for Nedo mEsstronic

Ref.-No.	Type	For model Ref.-No.
593 111	Case	583 111
595 111	Case	585 111
598 111	Case	588 111

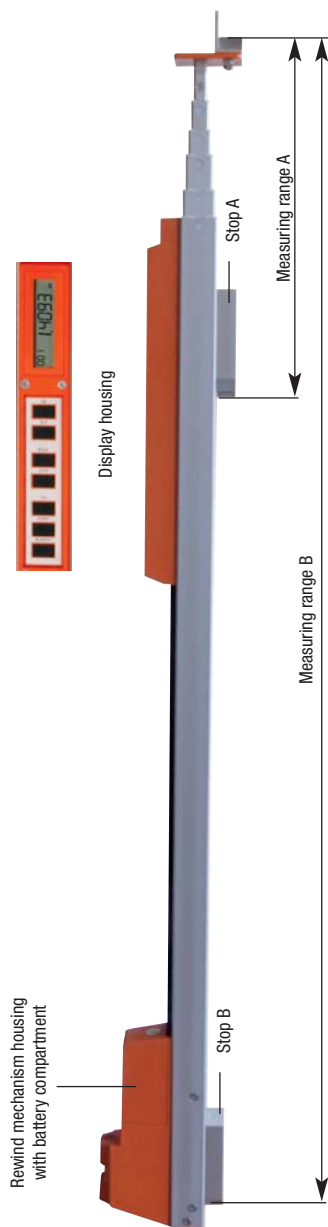

## Nedo mEsstronic 0.1

Nedo **mEsstronic 0.1** is an electronic length measuring tool for high precision measurements. Thanks to its high accuracy and the resolution of 0.1 mm this measuring tool is primarily used to measure of glazing bars.

The measured values are shown on the large, easy-to-read digital display. Two measuring ranges are at the user's disposal: 0.15 m to 2.35 m and 0.803 m to 3.00 m. It is possible to switch from one range to another at any time with the touch of a button.

Reference points for relative measurements can be set by using the zero function. **mEsstronic 0.1** features a data interface to save measured values on a memory module or to transfer them to a PC or to the control unit of a glazing bead saw.

### Features:

- Two measuring ranges:  
0.15–2.35 m and  
0.803–3.00 m (change of range via pushbutton)
- Resolution: 0.1 mm
- Accuracy:  $\pm 0.3$  mm
- Power supply: 4 x 1.5 V batteries type (AA) or 4 x 1.2 V rechargeable batteries
- Operation duration: approx. 150 hours
- Automatic switch-off after 3 minutes of non-use
- Zero function: sets reference points for relative measurements
- Recess for memory module, Bluetooth module or RS-232 module



### Nedo mEsstronic 0.1

Ref.-No.	Measuring range	Length retracted	Resolution	Weight
583 115	0.15 m to 2.35 m or 0.803 m to 3.00 m	0.803 m	0.1 mm	1.9 kg





## Accessories for Nedo mEsstronic and mEsstronic 0.1

### Nedo Bluetooth Module *BlueConnect*



The **Bluetooth module *BlueConnect*** permits simple wireless transmission of inside dimensions measured with the Nedo mEsstronic to a PC, pocket PC or to a machine control unit.

**Ref.-No. 585 228**

#### Features:

- Range: 10 m (class 2)
- Clearly visible blue LED display for operation mode
- Suitable for mEsstronic and mEsstronic 0.1
- Power supply via mEsstronic
- Port: Bluetooth 1.10, Serial Port Profile, Slave

### Nedo RS-232 Module



The **RS-232 module** allows for a transfer of measured values via a **RS-232** port to a PC or to the control unit of a glazing bead saw.

**Ref.-No. 585 226**

### Nedo Memory Module



The **memory module** stores 511 values measured with the mEsstronic or 250 values measured with the mEsstronic 0.1.

**Ref.-No. 585 115**

### Nedo Interface



**Interface** for data transfer from memory module to PC via RS-232-port.

As an alternative to analysing the measured values via the display the memory module can be connected to an interface to transfer the measured values to a PC.

**Ref.-No. 585 225**



® **laser mEssfix<sup>80</sup>**  
**Laser Distance Meter**

**For challenging  
projects**



The *laser mEssfix*<sup>80</sup> meets the requirements of protection class IP 54, making it ideally suited for use under difficult site conditions.



## Nedo *laser mEssfix*<sup>80</sup>

The *laser mEssfix*<sup>80</sup> is a small, handy and extremely robust laser distance meter for real professionals. It has a measuring range of 0.05 m to 80 m and an accuracy of  $\pm 1.5$  mm.

Measurements can be taken from the device's front edge, back edge or multi-functional end piece with automatic position detection.

Numerous measuring functions help to save time during surveying operations.



### Features:

- Measurements can be made from the device's front edge, back edge or end piece
- Multi-functional end piece with automatic position detection
- Clear, back-lit 3-line display
- Illuminated display
- Area and volume calculation
- 2 Pythagoras functions
- Single or continuous measuring
- Addition / Subtraction
- Memory for the last ten measurements
- Small, handy and robust
- IP 54 splashwater protection
- Information on range and accuracy comply with ISO 16331-1



### Nedo *laser mEssfix*<sup>80</sup>

Ref.-No.	705 565
Typ. measuring accuracy	$\pm 1.5$ mm
Measuring range	0.05 m to 80 m
Laser	laser class 2, 635 nm
Automatic switch-off	after approx. 3 minutes
Power supply	2 x 1.5 V type AAA batteries
Measurements per battery set	approx. 3000
Dimensions	approx. 117 mm x 57 mm x 32 mm
Weight	137 g





## Leica DISTO™ X310

The extremely robust housing is dust-proof and splashwater protected in accordance with IP 65. The **DISTO™ X310** can even be cleaned under running water.

**Ref.-No. 705 562**



### Features:

- Accuracy:  $\pm 1.0$  mm
- Measuring range: 0.05 m - 120 m
- Dust-proof and splashwater protected in accordance with IP 65
- Minimum/maximum measuring
- Painter function
- Area and volume calculation
- Pythagoras function
- Addition / subtraction
- Multi-functional end piece with automatic position detection
- Time delay release



## Leica DISTO™ D5

The integrated digital pointfinder with 4x zoom permits easy and exact measurements outdoors, even over great distances.

**Ref.-No. 705 548**



### Features:

- Accuracy:  $\pm 1.0$  mm
- Measuring range: 0.05 m - 200 m
- Digital viewfinder with 4 x zoom and high resolution colour display
- Inclination sensor 45°
- Minimum/maximum measuring
- Area and volume calculation
- Pythagoras function
- Addition / subtraction
- Horizontal distance past obstructions
- Trapezium measurements



Bluetooth® Smart technology allows data transfer to smartphones and tablets. In addition to the smart free App Leica DISTO™ sketch, there is also a host of other Apps to allow you to work efficiently and avoid typing errors when recording measurement results.



## Leica DISTO™ D510

The Leica DISTO™ D510 allows easy and trouble-free distance measuring outdoors. The unique combination of digital pointfinder and 360° tilt sensor permits measurements which would be impossible using conventional instruments.

**Ref.-No. 705 564**



### Features:

- Accuracy:  $\pm 1.0$  mm
- Measuring range: 0.05 m - 200 m
- Digital viewfinder with 4 x zoom and high resolution colour display
- Dust-proof and splashwater protected in accordance with IP 65
- Height profile measurements
- Pythagoras function
- Horizontal distance past obstructions
- Trapezium measurements
- Free App - Leica DISTO™ sketch for creating drawings or for dimensioning photos
- Bluetooth® smart interface



## Leica DISTO™ D810 touch

The Leica DISTO™ D810 touch is the world's first distance measurement device with a touchscreen. Operation is quick and intuitive. Another revolutionary feature is distance measurement in photos. The integrated camera takes photos which can be downloaded to a computer via the USB interface.

**Ref.-No. 705 567**



### Features:

- Accuracy:  $\pm 1.0$  mm
- Measuring range: 0.05 m - 200 m
- Digital viewfinder with 4 x zoom and high resolution colour display
- Overview camera
- Measure with a picture
- Precise 360° tilt sensor
- Smart Horizontal Mode™
- Height tracking
- Bluetooth® smart interface
- Free App - Leica DISTO™ sketch for creating drawings or for dimensioning photos

Degrees can be read off immediately  
from the analogue display.  
Display graduations:  $\pm 0.5^\circ$   
Measuring accuracy:  $\pm 0.25^\circ$



## Nedo Winkelfix

With the Nedo **Winkelfix**, measurements of angles are performed quickly, precisely and with the utmost ease.

Simply place the Nedo **Winkelfix** in position and the angle can be rapidly read off from the analogue display. Two integral spirit levels ensure true horizontal and vertical positioning. Thanks to its reliability, sturdiness and convenience, the Nedo **Winkelfix** has proven its value to the building trade over and over again.

You too will find measuring angles easier with one of our five Winkelfix models!



Winkelfix long



Winkelfix classic and mini



Winkelfix maxi and shorty



### Nedo Winkelfix

Ref.-No.	Shank length	Graduations	Measuring range	Compass points	Weight
450 111 mini	430 mm	degrees	0 to 180°	no	0.9 kg
450 121 classic	600 mm	degrees	0 to 180°	no	1.4 kg
500 101 shorty	305 mm	degrees	0 to 180°	no	0.7 kg
500 111 maxi	600 mm	degrees	0 to 180°	yes	1.4 kg
510 111 long	1500 mm	degrees	0 to 180°	yes	2.6 kg

### Cases for Nedo Winkelfix

Ref.-No.	Type	For model Ref.-No.
550 111-613	Case	450 111 Winkelfix mini
600 111-613	Case	450 121 Winkelfix classic
600 101	Case	500 101 Winkelfix shorty
600 111-613	Case	500 111 Winkelfix maxi
610 111	Case	510 111 Winkelfix long

Degrees can be read off immediately from the digital display.  
 Display graduations:  $\pm 0.1^\circ$   
 Measuring accuracy:  $\pm 0.2^\circ$



## Nedo Winkeltronic Easy

Digital angle measuring tool for measuring and transferring angles. Thanks to its light weight and large display, the **Winkeltronic Easy** is ideal for use on construction sites, especially for interior outfitting.

### Features:

- Accuracy:  $\pm 0.2^\circ$
- Hold function keeps a value on the display
- Zero adjustment at any shank angle
- Integrated horizontal and vertical spirit levels
- Power supply: 2 x 1.5 V (AA) batteries or 2 x 1.2 V rechargeable batteries
- Measurements of absolute, relative and opposite angles
- Supplied with case as a standard

### Nedo Winkeltronic Easy

Ref.-No.	Shank length	Resolution	Measuring range	Weight
405 100	400 mm	0.1°	0 to 200°	0.65 kg
405 120	600 mm	0.1°	0 to 200°	0.88 kg



## Nedo Winkeltronic

The premium digital angle measuring tool for exact measuring and transferring of angles. Accuracy of  $\pm 0.1^\circ$ . Extremely robust and reliable.

### Features:

- Accuracy:  $\pm 0.1^\circ$
- Hold functions keep a value on the display
- Zero adjustment at any shank angle
- Integrated horizontal and vertical spirit levels
- Power supply: 4 x 1.5 V (AA) batteries or 4 x 1.2 V rechargeable batteries
- Automatic switch-off after 3 minutes of non-use

### Nedo Winkeltronic

Ref.-No.	Shank length	Resolution	Measuring range	Weight
405 215	450 mm	0.1°	0° to 352°	1.2 kg
405 315	600 mm	0.1°	0° to 355°	1.5 kg

### Cases for Nedo Winkeltronic

Ref.-No.	Type	For model Ref.-No.
550 111-613	Case	405 215 Winkeltronic
600 111-613	Case	405 315 Winkeltronic

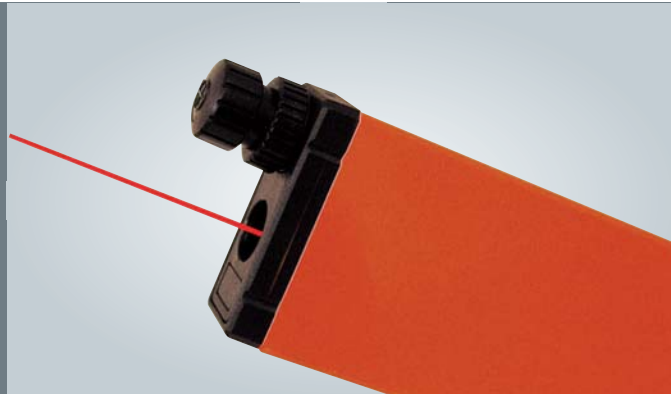

## Nedo LaserWinkeltronic

The Nedo **LaserWinkeltronic** combines the advantages of the latest laser technology with the proven technology of the Nedo Winkeltronic. Many applications, such as measuring and adjusting angles when installing staircases, interior outfitting, modernisation projects and measuring roof angles are considerably simplified by the use of laser technology. Time-consuming conversions are eliminated and deviations from straight lines can be seen immediately.

The laser beam travels in straight lines from the shanks of the instrument extending them up to 20 m. The Nedo LaserWinkeltronic is available with one or two laser beams.



### Features Winkeltronic:

- Resolution: 0.1°
- Accuracy:  $\pm 0.1^\circ$
- Hold function keeps a value on the display
- Zero adjustment at any shank angle
- Integrated horizontal and vertical spirit levels
- Power supply: 4 x 1.5 V batteries (AA)

### Features Laser:

- Laser class 2
- Visible red laser beam, wavelength 635 nm
- Beam diameter: 6 mm
- Range: approx. 20 m, depending on surrounding conditions
- Accuracy:  $\pm 0.5$  mm/m
- Power supply: 2 x 1.5 V batteries (AAA)

### Nedo LaserWinkeltronic

Ref.-No.	Laser modules	Shank length	Resolution	Measuring range	Weight
460 613	1	605 mm	0.1°	0° to 360°	1.5 kg
460 612	2	605 mm	0.1°	0° to 360°	1.5 kg

### Case for Nedo LaserWinkeltronic

Ref.-No.	Type	For model Ref.-No.
600 111-613	Case	460 612 und 460 613





## Nedo Inclinometer Level

Inclines, gradients and angles can be easily determined with the Nedo **inclinometer level**. Measured values are displayed alternatively in degrees or percent.

An audible signal at 0° and 90° facilitates adjustments, and therefore, visual contact with the display is not necessary. A measured value can be retained on the display when activating the hold function.

The Nedo **inclinometer level** is easy to operate, rugged and splash-proof.

### Features:

- Easy-to-read display
- Digital display inverts automatically for overhead measurement
- Automatic switch-off after approx. 5 minutes of non-use
- Hold function keeps a value on the display
- Supplied with case as a standard



### Nedo Inclinometer Level

Ref.-No.	Measuring range	Length	Degrees display	Percent display	Accuracy	Weight
508 110	360°	600 mm	in 0.1° increments	in 0.1% increments	± 0.2°	0.7 kg
508 111	360°	800 mm	in 0.1° increments	in 0.1% increments	± 0.2°	0.8 kg



## LASERS / ACCESSORIES

---

## Developed by Specialists, Manufactured by Experts, Prized by Construction Professionals.

Nedo offers a unique range of innovative dot, line and rotating lasers for rapid levelling, vertical alignment, plumbing and squaring jobs. Nedo lasers are renowned for their simple, intuitive operation, extremely robust design for use under harsh conditions and high precision.

With their ingenious functions and intelligent range of accessories, Nedo laser products are genuine system solutions that open the way to significantly increased productivity in the building trades.





## Nedo Dot and Line Lasers at a Glance!

Product	X-Liner <sup>5P</sup>	X-Liner <sup>2</sup>	X-Liner <sup>5.2</sup>	X-Liner <sup>3</sup>
---------	-----------------------	----------------------	------------------------	----------------------

Laser configuration



Laser functionality	5-beam point laser	Cross line laser	Cross line/5-beam point laser	Multi-line laser
---------------------	--------------------	------------------	-------------------------------	------------------

Technical data:				
Laser class	2, 635 nm	2M, 635 nm	2M, 630-680 nm	2M, 630-680 nm
Protection class	IP 54	IP 54	IP 54	IP 54
Self levelling range	± 4°	± 4°	± 4°	± 3°
Power supply	2 x 1.5 V type mignon/AA	3 x 1.5 V type mignon/AA	3 x 1.5 V type mignon/AA	4 x 1.5 V type mignon/AA
Laser receiver	optional	optional	optional	optional

Applications:				
Dry lining	**	**	***	***
Interior finishing	**	**	***	***
Electrical installations	**	**	***	**
Carpentry	*	**	***	***
Sanitary installations	*	**	***	**
Alignment of construction components		**	***	***
Tiling		**	***	**
Ceiling and steel construction		*	**	**
Paintwork		***	**	*
Installation of doors and windows		**	***	***
Metre marking in interior work		*	**	**
360° horizontal line				

\* limited    \*\* good    \*\*\* optimal





X-Liner <sup>4</sup>	QUASAR <sup>2</sup>	QUASAR <sup>4</sup>	QUASAR <sup>6</sup>
----------------------	---------------------	---------------------	---------------------



Multi-line laser	Cross line laser	Multi-line laser	Multi-line laser
------------------	------------------	------------------	------------------

2M, 630-680 nm	2M, 635 nm	2M, 635 nm	2M, 635 nm
IP 54	IP 54	IP 54	IP 54
± 3°	± 4°	± 3.5°	± 3.5°
4 x 1.5 V type mignon/AA optional	4 x 1.5 V type mignon/AA optional	4 x 1.5 V type mignon/AA optional	rechargeable batteries NiMH, 2300 mAh optional

***	***	***	***
***	**	***	***
**	**	**	**
***	**	***	**
**	**	***	**
***	**	***	***
**	***	***	*
**	*	**	**
*	***	***	*
***	**	***	***
**	*	***	*
		***	

Easy, single-button operation. Reliable, magnetically damped pendulum for precise results. The device self-levels automatically on inclines of up to 4° so that the laser points from the X-Liner<sup>5P</sup> are always projected exactly vertically or horizontally.

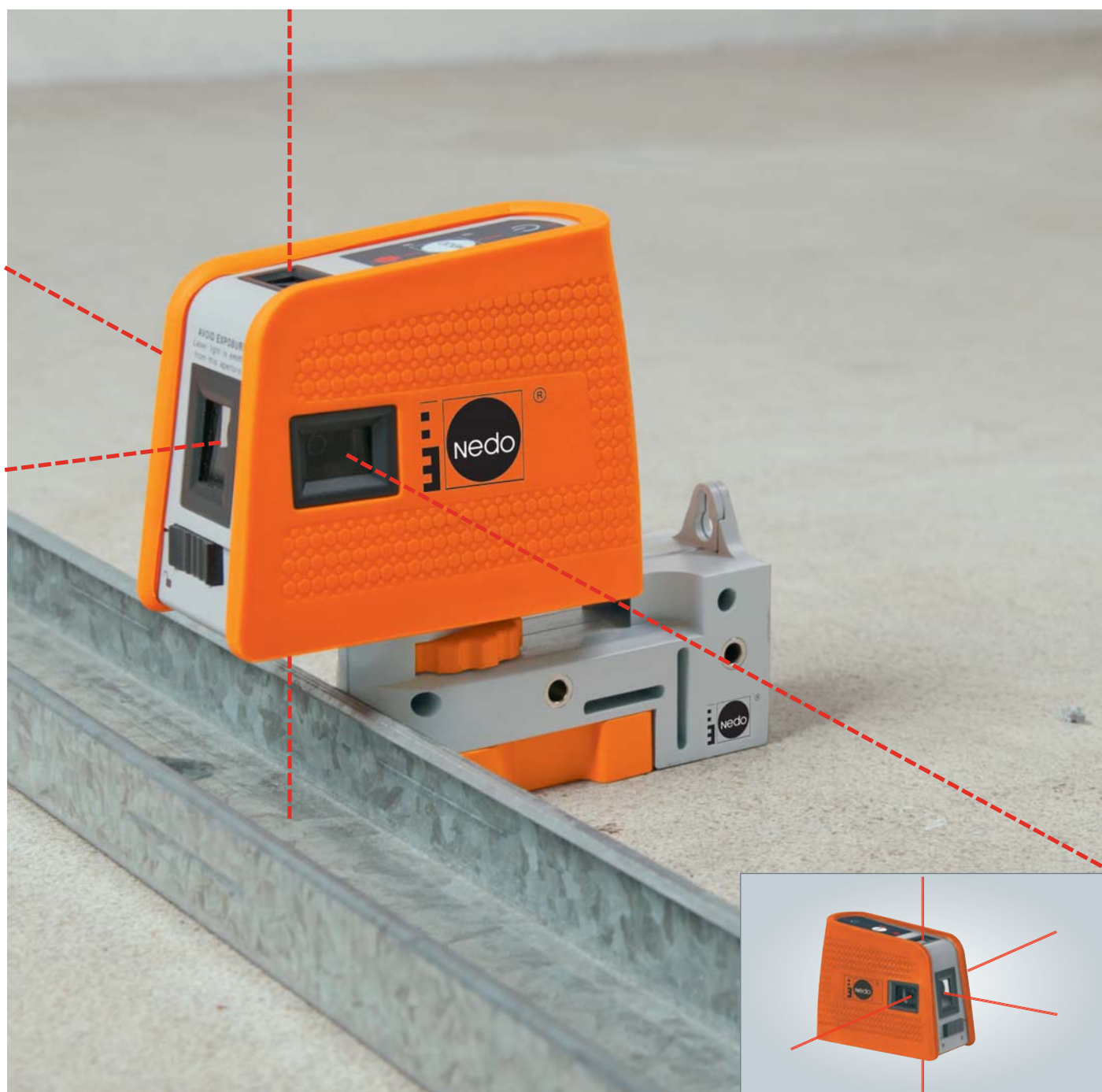

The strong magnet on the universal adapter allows the X-Liner<sup>5P</sup> to be easily attached to steel girders.



## Nedo X-Liner<sup>5P</sup>

A self-levelling 5-beam point laser which transmits three horizontal and two vertical laser points: to the front, left, right, up and down.

The laser points are arranged in an exact right angle to one another. The horizontal laser points are all at one height. Ideal for rapid horizontal levelling, vertical alignment, plumbing and for marking off right angles jobs.

### Features:

- 5 highly visible laser points aligned exactly at right angles
- Reliable self-levelling operation
- Robust pendulum with magnetic damping
- Universal adapter with strong magnet, 1/4" and 5/8" mounting thread



Scope of delivery:  
**X-Liner<sup>5P</sup>**, universal adapter with 1/4" and 5/8" mounting thread and magnet, fixing straps, target board, batteries and carrying case  
**Ref.-No. 460 871**

### Perfect for levelling, aligning and marking 90° angles, especially for applications such as:

- Dry lining
- Electrical installations
- Carpentry
- Sanitary installations
- Alignment of construction components

### Nedo X-Liner<sup>5P</sup>

<b>Ref.-No.</b>	<b>460 871</b>
Accuracy	± 0.3 mm/m
Self-levelling range	± 4°
Working range	approx. 30 m
Laser	Laser class 2, 635 nm
Protection class	IP 54
Power supply	2 x 1.5 V type mignon / AA
Operation duration	approx. 33 h
Connecting thread	1/4"

The clearly arranged console allows for easy handling and the reliable, magnetically damped pendulum ensures precise results at all times.  
The device will automatically self-level at inclines of up to 4°.







## Nedo X-Liner<sup>2</sup>

Self-levelling cross line laser with one vertical and one horizontal line. The highly visible laser cross on the wall allows rapid and precise levelling and alignment. Thanks to the pulse function, the **X-Liner<sup>2</sup>** can be used with the **ACCEPTOR<sup>line</sup>** laser receiver even in adverse light conditions.

### Features:

- Self-levelling cross line laser for levelling and alignment
- Highly visible horizontal and vertical laser line, can be activated separately
- Pulse function for use with the **ACCEPTOR<sup>line</sup>** laser receiver
- Reliable magnetic damping
- Tilt function
- Universal adapter with strong magnet and 1/4" and 5/8" mounting thread



Scope of delivery:

**X-Liner<sup>2</sup>**, universal adapter, ball joint adapter, fixing straps, batteries, target board and carrying case

**Ref.-No. 460 870**

### Perfect for levelling and aligning especially for applications such as:

- Dry lining and interior work
- Tiling
- Surfacing and steel constructions
- Electrical installations
- Paint jobs
- Sanitary installations

## Nedo X-Liner<sup>2</sup>

Ref.-No.	460 870
Accuracy	± 0.3 mm/m
Self-levelling range	± 4°
Working range	approx. 15 m
Laser	Laser class 2M, 635 nm
Protection class	IP 54
Power supply	3 x 1.5 V type mignon / AA
Operation duration	approx. 20 h
Connecting thread	1/4"



Optional accessory:

Laser receiver **ACCEPTOR<sup>line</sup>**

**Ref.-No. 430 326-613**

On page 51

The clearly arranged console allows for easy handling. The laser lines and the laser points can be activated separately. The reliable, magnetically damped pendulum ensures precise results at all times. The device will automatically self-level at inclines of up to 4°.



## Nedo X-Liner<sup>5.2</sup>

The **X-Liner<sup>5.2</sup>** is the ingenious combination of a cross line laser and a 5-point laser. Five laser points are aligned at exact right angles to one another and are supplemented by a horizontal and a vertical laser line which means the **X-Liner<sup>5.2</sup>** is extraordinarily flexible in use where levelling, alignment, plumbing or squaring jobs need to be done. Thanks to the pulse function the **X-Liner<sup>5.2</sup>** together with the **ACCEPTOR<sup>line</sup>** laser receiver can also be deployed even when light conditions are unfavourable.



Scope of delivery:  
**X-Liner<sup>5.2</sup>**, multi-functional  
 adapter, target board, batteries  
 and carrying case  
**Ref.-No. 460 872**

### Features:

- Self-levelling cross line/5-beam point laser for levelling, alignment, plumbing and squaring jobs
- Highly visible laser points and laser lines
- The laser lines can be activated separately
- Pulse function for the use of the optional **ACCEPTOR<sup>line</sup>** laser receiver
- Reliable magnetic damping
- Tilt function
- Universal adapter with strong magnet and 1/4" and 5/8" mounting thread

### Perfect for levelling, aligning and marking right angles, especially for applications such as:

- Dry lining and interior work
- Tiling
- Surfacing and steel constructions
- Electrical installations
- Paint jobs
- Sanitary installations

## Nedo X-Liner<sup>5.2</sup>



Optional accessory:  
 Laser receiver **ACCEPTOR<sup>line</sup>**  
**Ref.-No. 430 326-613**  
 On page 51

Ref.-No.	460 872
Accuracy	± 0.3 mm/m
Self-levelling range	± 4°
Working range	approx. 30 m
Laser	Laser class 2M, 630-680 nm
Protection class	IP 54
Power supply	3 x 1.5 V type mignon / AA
Operation duration	approx. 15 h
Connecting thread	1/4"



The fine adjustment knob allows the direction of alignment to be simply and exactly aligned even over large distances. As the laser lines are arranged exactly at right angles to one another the **X-Liner<sup>3</sup>** is ideal for transferring right angles. The graduation also allows other angles to be transferred quickly.

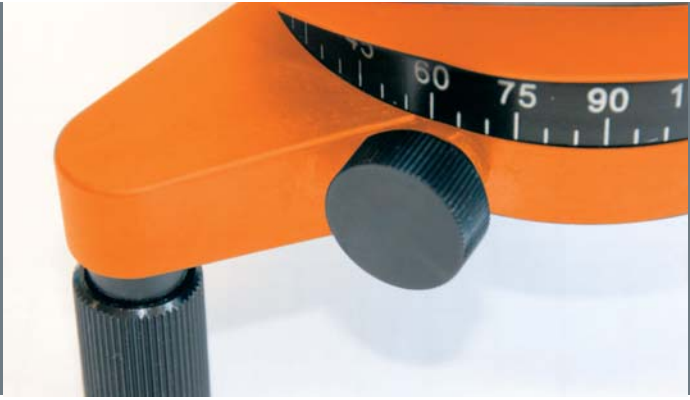



The neatly arranged control panel ensures simple and intuitive handling. The laser lines can be activated and deactivated separately.



As the centre of rotation is in line with the plummet beam and the ceiling cross, it is particularly easy to handle the X-Liner<sup>3</sup>. The multi-line laser X-Liner<sup>3</sup> can also be used as a zenith plummet.



Scope of delivery:  
X-Liner<sup>3</sup>, target board, batteries and carrying case  
Ref.-No. 460 873



Optional accessory:  
Laser receiver **ACCEPTOR<sup>line</sup>**  
Ref.-No. 430 326-613  
On page 51

## Nedo X-Liner<sup>3</sup>

Self-levelling multi-line laser for levelling, alignment, plumbing and for the easy transfer of right angles in interior work.

The self-levelling mechanism with its robust magnetically damped pendulum will automatically self-level at inclines of up to 3°. Thanks to the pulse function the X-Liner<sup>3</sup> together with the **ACCEPTOR<sup>line</sup>** laser receiver can also be deployed even when light conditions are unfavourable.

### Features:

- Self-levelling multi-line laser for levelling, alignment, plumbing and easy squaring jobs
- One laser cross on each of the two walls
- Laser cross on the ceiling and plumb point on the floor
- Highly visible laser lines, can be activated separately
- Pulse function for use with the optional **ACCEPTOR<sup>line</sup>** laser receiver
- Robust pendulum with magnetic damping
- Sturdy housing, splash-proof as per IP 54
- Fine adjustment for exact alignment of the axes
- Slewable tripod with 360° graduation
- 5/8" mounting thread

### Perfect for levelling, aligning and marking right angles, especially for applications such as:

- Metre marking in interior work
- Dry lining
- Surfacing
- Tiling
- Installation of doors and windows
- Structural steel work

## Nedo X-Liner<sup>3</sup>

Ref.-No.	460 873
Accuracy	± 0.3 mm/m
Self-levelling range	± 3°
Working range	approx. 25 m
Laser	Laser class 2M, 630-680 nm
Protection class	IP 54
Power supply	4 x 1.5 V type mignon / AA
Operation duration	approx. 20 h
Connecting thread	5/8"

The fine adjustment knob allows the direction of alignment to be simply and exactly aligned even over large distances. As the laser lines are arranged exactly at right angles to one another the **X-Liner 4** is ideal for transferring right angles. The graduation also allows other angles to be quickly transferred.

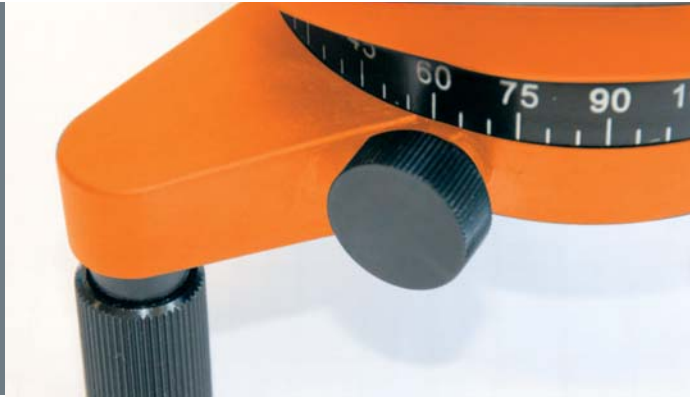

The clearly arranged control panel ensures simple, intuitive operation. The laser lines can be activated separately.



## Nedo X-Liner<sup>4</sup>

Self-levelling multi-line laser for levelling, alignment, plumbing and easy squaring in dry lining work. Thanks to the three vertical laser lines which are arranged at exact right angles to each other and cut by a very long horizontal laser line, the **X-Liner<sup>4</sup>** transfers a laser cross each to three walls.

With the help of the plumb point on the floor and the intersection point of the three vertical laser lines on the ceiling, the **X-Liner<sup>4</sup>** can also be used as a zenith plummet. Thanks to the pulse function the **X-Liner<sup>4</sup>** together with the **ACCEPTOR<sup>line</sup>** laser receiver can also be deployed even when light conditions are unfavourable.



Scope of delivery:  
**X-Liner<sup>4</sup>**, target board, batteries  
and carrying case  
Ref.-No. 460 874

### Features:

- Self-levelling multi-line laser for levelling, alignment, plumbing and easy squaring jobs
- One laser cross on each of the three walls
- Laser cross on the ceiling and plumb point on floor
- Highly visible laser lines, can be activated separately
- Pulse function for use with the optional **ACCEPTOR<sup>line</sup>** laser receiver
- Robust pendulum with magnetic damping
- Sturdy housing, splash-proof as per IP 54
- Fine adjustment for exact alignment of axes
- Slewable tripod with 360° graduation
- 5/8" mounting thread

### Perfect for levelling, aligning and marking right angles, especially for applications such as:

- Metre marking in interior work
- Dry lining
- Surfacing
- Tiling
- Installation of doors and windows
- Structural steel work

## Nedo X-Liner<sup>4</sup>

Ref.-No.	460 874
Accuracy	± 0.3 mm/m
Self levelling range	± 3°
Working range	ca. 25 m
Laser	Laser class2M, 630-680 nm
Protection class	IP 54
Power supply	4 x 1.5 V type mignon / AA
Operation duration	ca. 15 h
Connecting thread	5/8"



Optional accessory:  
Laser receiver **ACCEPTOR<sup>line</sup>**  
Ref.-No. 430 326-613  
On page 51



The **QUASAR<sup>2</sup>** cross line laser is fixed to the **Simplicx** multi-functional bracket by means of an innovative click-in locking system that works much like a ski binding. There is no cumbersome clamping screw for holding the laser in place. Moreover, the click-in locking system allows smooth rotation of the **QUASAR<sup>2</sup>** by 360°.

It could hardly be easier!



### Multi-functional bracket **Simplicx**

Thanks to the well-thought-out **Simplicx** fastening system, the **QUASAR<sup>2</sup>** cross line laser can be fastened practically anywhere: on walls, steel girders, pipes, poles, ceilings, drywall sections or the floor. And of course you can also mount the **QUASAR<sup>2</sup>** on a tripod. The **Simplicx** multi-functional bracket is vertically adjustable and features both rough and fine adjustment for quick and precise height setting.

- 1 Eyelet for fixing to a screw
- 2 Extra-strong magnets for fixing to steel girders
- 3 Robust tension belt for fixing to beams, pipes etc.
- 4 Adjustable quick-locking system for easy fixing to ceiling sections and battens of varying diameters
- 5 Click-in locking system for fixing the laser to the **Simplicx** multi-functional bracket
- 6 Rough and fine adjustment allows rapid height settings

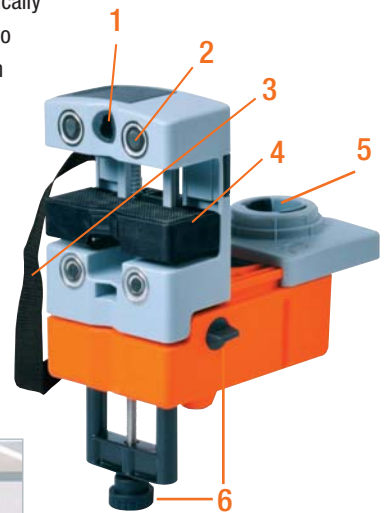

1



2



3

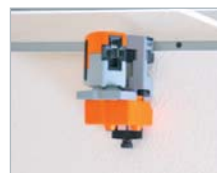

4



### 1000 applications – 1 solution

With the aid of the Simplix multi-functional support, the **QUASAR<sup>2</sup>** cross line laser can be fastened practically anywhere. It can even be positioned above a drywall profile for alignment.

Nothing could be more flexible than that!

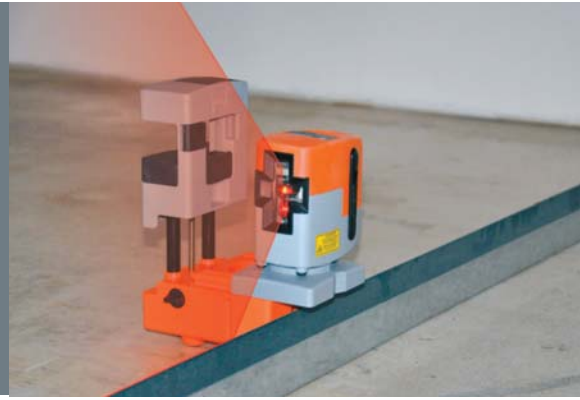

## Nedo QUASAR<sup>2</sup> Simplix Set

1000 applications - 1 solution

The **QUASAR<sup>2</sup> Simplix Set** provides a clever and complete solution for levelling and for taking alignments in interior finishing work.

Perfect for tiling, dry wall construction, ceiling construction, installation of doors and windows, paintwork, electrical installations. The very bright and highly visible laser lines can be individually switched on as required. With the aid of the Simplix multi-functional bracket, the **QUASAR<sup>2</sup>** can be fastened anywhere, which makes it extraordinarily flexible in use where levelling and alignment jobs need to be done.



Scope of delivery **QUASAR<sup>2</sup> Simplix Set**:

**QUASAR<sup>2</sup>**, multifunctional bracket

Simplix, laser glasses, target board,  
batteries and carrying bag

Ref.-No. 460 880-613

### Features:

- Self-levelling cross line laser for levelling and aligning
- Easy-to-read horizontal and vertical laser line that can be switched on separately
- Pulse mode for use with optional **ACCEPTOR<sup>line</sup>** laser receiver
- Robust design suitable for use under difficult site conditions
- Reliable magnetic damping
- Easy-to-operate click-in locking system for fixing the **QUASAR<sup>2</sup>** to the Simplix multi-function bracket
- Tilt function
- 1/4" connecting thread
- Reliable compensator lock for transportation
- The laser can be turned smoothly through 360° on the Simplix multi-functional bracket

**Perfect for levelling, aligning and marking right angles, especially for applications such as:**

- Interior finishing
- Dry wall construction
- Surfacing
- Tiling
- Installation of doors and windows
- Steel construction

## Nedo QUASAR<sup>2</sup>



Scope of delivery **QUASAR<sup>2</sup>**:

**QUASAR<sup>2</sup>**, target board, batteries and  
carrying bag

Ref.-No. 460 881-613

Ref.-No.	460 880-613 QUASAR <sup>2</sup> Simplix Set
Ref.-No.	460 881-613 QUASAR <sup>2</sup>
Accuracy	± 0.3 mm/m
Self-levelling range	± 4°
Working range	approx. 20 m
Laser	Laser class 2M, 635 nm
Protection class	IP 54
Power supply	4 x 1.5 V type mignon / AA
Operation duration	approx. 25 h
Connecting thread	1/4"

The horizontal 360° laser line of the **QUASAR<sup>4</sup>** makes it an attractive alternative to a rotating laser. As the horizontal laser line is generated by three laser diodes, it is much more visible than the beams in laser class 2 rotating lasers. Additional applications are permitted by the downward plumb beam and the two vertical laser lines, which are arranged exactly at right angles to each other and intersect at the ceiling.

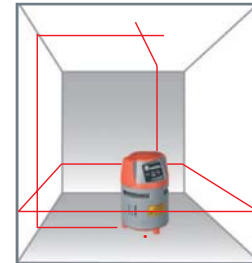

**360°**  
**Horizontal line**

The **QUASAR<sup>4</sup>** is distinguished by an especially robust design. The floor assembly is made of aluminium, and the compact housing is splash-proof protected in accordance with IP 54, making it perfect for tough applications on construction sites.

Owing to the compact design and the location of the plumb point at the centre of rotation, aligning the axis of the **QUASAR<sup>4</sup>** is especially easy. Thanks to the pulse function the **QUASAR<sup>4</sup>** together with the **ACCEPTOR<sup>line</sup>** laser receiver can also be deployed even when light conditions are unfavourable.



With the aid of the Simplix multi-functional support, the **QUASAR<sup>4</sup>** can be fastened practically anywhere. This makes it especially versatile. It is perfect for levelling, alignment, squaring and plumbing in interior finishing. It is also ideal for tile laying, surfacing, dry lining and many other indoor jobs.



## Nedo QUASAR<sup>4</sup> Simplix Set

The self-levelling multi-line **QUASAR<sup>4</sup>** laser generates a bright, highly visible horizontal 360° laser line, making it an attractive alternative to a rotating laser in indoor finishing. In addition, it generates two vertical laser lines which are arranged exactly at right angles to each other, intersect at the ceiling and are highly visible on the floor even right near the device. An additional laser beam transfers the cross from the ceiling to the floor.

### Features:

- Self-levelling multi-line laser for levelling, alignment, plumbing and marking off right angles
- Horizontal 360° laser line
- A laser cross on each of two walls
- Laser cross and plumb point on the floor
- Highly visible laser lines, can be activated separately
- Axis alignment is simple because the plumb point is at the axis of rotation
- Pulse function for use with the optional **ACCEPTOR<sup>line</sup>** laser receiver
- Robust design for use under difficult site conditions
- Sturdy housing, splash-proof protected in accordance with IP 54
- Reliable magnetic damping
- Easy-to-operate click-in locking system for fixing the **QUASAR<sup>4</sup>** to the Simplix multi-functional bracket
- Smooth 360° rotation of the laser for alignment of the axis on the Simplix multi-functional bracket

### Perfect for levelling, aligning and marking right angles, especially for applications such as:

- Metre marking in interior work
- Dry lining
- Ceiling construction
- Tiling
- Installation of doors and windows
- Steel construction



Scope of delivery **QUASAR<sup>4</sup> Simplix Set**: **QUASAR<sup>4</sup>**, multifunctional bracket Simplix, laser glasses, target board, NiMH rechargeable batteries with low self-discharge loss, charger and transport case  
**Ref.-No. 460 885**



Scope of delivery **QUASAR<sup>4</sup>**: **QUASAR<sup>4</sup>**, target board, laser glasses, batteries and transport case  
**Ref.-No. 460 886**

### Nedo QUASAR<sup>4</sup>

Ref.-No.	460 885 QUASAR <sup>4</sup> Simplix Set
Ref.-No.	460 886 QUASAR <sup>4</sup>
Accuracy	± 0.3 mm/m
Self-levelling range	± 3.5°
Working range ø	approx. 40 m without laser receiver approx. 100 m with laser receiver
Laser	laser class 2M, 635 nm
Protection class	IP 54
Power supply	4 x 1.5 V type mignon / rechargeable batteries AA NiMH
Operation duration	approx. 18 h
Connecting thread	5/8"



Bright and clearly visible laser lines. Ideal for alignment and marking of right angles in drywall construction. Using the fine adjustment feature, the alignment direction can be set easily and accurately even over long distances.



Thanks to the practical tripod, the **QUASAR<sup>6</sup>** can be positioned above the drywall section. Since the plumb point, the rotary axis and the intersection point of the vertical lines match, handling of the **QUASAR<sup>6</sup>** is particularly easy.

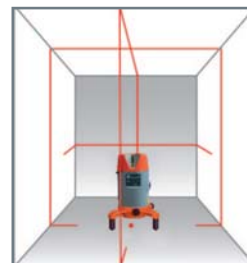





Simple transposition of plumb points and lines onto the ceiling.



The dependable self-levelling feature permits rapid position changes of the **QUASAR<sup>6</sup>**. Sturdy and dependable for rugged construction site conditions.

## Nedo QUASAR<sup>6</sup>

Self-levelling multi-line laser for levelling, aligning, plumbing and marking 90° angles. Four vertical laser lines and one horizontal laser line generate a cross on one wall and on the ceiling. An additional plumb beam transfers the cross from the ceiling to the floor. Optimum for drywall construction.

### Features:

- Highly visible laser beams; can be switched on separately
- Reliable self-levelling function
- Compensator lock for transportation
- Tangent screw for fine adjustment
- Reliable magnetic damping
- Pulse mode for use with optional **ACCEPTOR<sup>line</sup>** laser receiver
- Rechargeable batteries with run charge function
- Quick charge, max. 2.5 h to charge (when QUASAR<sup>6</sup> is turned off)
- Quick-Fix rapid locking system for quick and easy fixing to a tripod with 5/8" mounting thread
- Rugged design with shock protection system



Scope of delivery **QUASAR<sup>6</sup>**:  
**QUASAR<sup>6</sup>**, target board, 5/8" adapter,  
 Quick-Fix adapter, laser glasses,  
 rechargeable batteries, charger and case  
**Ref.-No. 460 930**

### Perfect for levelling, aligning and marking right angles, especially for applications such as:

- Dry wall construction
- Interior finishing
- Tiling
- Installation of doors and windows
- Ceiling and steel construction
- Paintwork
- Electrical installations
- Sanitary installations

## Nedo QUASAR<sup>6</sup>



Scope of delivery **QUASAR<sup>6</sup> Set**:  
**QUASAR<sup>6</sup>**, laser receiver **ACCEPTOR<sup>line</sup>**  
 with rod clamp, target board, 5/8" adapter,  
 Quick-Fix adapter, laser glasses,  
 rechargeable batteries, charger and case  
**Ref.-No. 460 932**

Ref.-No.	<b>460 930 QUASAR<sup>6</sup></b>
Ref.-No.	<b>460 932 QUASAR<sup>6</sup> Set</b>
Accuracy	± 0.3 mm/m
Self-levelling range	± 3.5°
Working range	approx. 25 m without receiver approx. 50 m with receiver
Laser	Laser class 2M, 630-680 nm
Protection class	IP 54
Power supply	rechargeable batteries NiMH, 2300 mAh
Operation duration	approx. 20 h
Connecting thread	5/8"



# Nedo Laser Accessories for Line Lasers

## Monopod

Sturdy monopod for holding line and rotating lasers, especially in tight spaces. The monopod is clamped between the floor and the ceiling. Suitable for rooms up to 3.40 m in height. Comes with a sturdy laser adapter that is fixed to the monopod at the required working height. The laser adapter has a variety of attachment options:

### Features:

- 1/4" clamping screw for line lasers
- 5/8" clamping screw for rotating lasers
- Easy mount for Simplicx multi-functional support

Ref.-No. 460 995



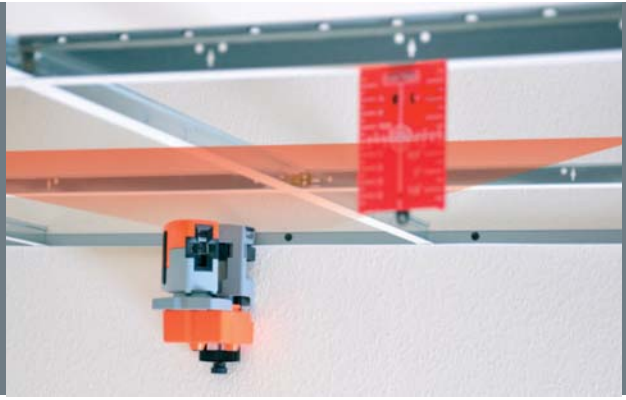

## Nedo Laser Accessories for Interior Finishing

### Laser Receiver ACCEPTOR<sup>line</sup>



#### Technical data:

- Length of detector field: 20 mm
- Working range: 5 m to 50 m
- Power supply: 1 x 9 V-Block, 6LR 61
- Operation duration: approx. 50 h
- Automatic switch-off: after 10 minutes of non-use
- Operating temperature: -20°C to +50°C
- Connecting: 1/4"-thread
- Protection class: IP 54



Ref.-No. 430 326-613

### Charger



#### Features:

- Comes with 4 NiMH rechargeable AA batteries
- Capacity: 2,100 mAh
- Low self-discharge loss
- Suitable for X-Liner series, QUASAR<sup>2</sup> and QUASAR<sup>4</sup>

Ref.-No. 030 824

### Magnetic Target Board Red or Green



The target board is attached to the ceiling profiles with magnets.

For red and green lasers.

Ref.-No. 460 907-613 (red)

Ref.-No. 460 908-613 (green)

### Laser Glasses Red or Green



Improves the visibility of laser beams.

For red and green lasers.





Ref.-No. 051 790 (red)

Ref.-No. 061 607 (green)





## Nedo Rotating Lasers at a Glance!

Product	SIRIUS <sup>1</sup> H	SIRIUS <sup>1</sup> HV	SIRIUS <sup>1</sup> HV green
Laser configuration		 	 
Laser functionality	Rotating laser horizontal	Rotating laser horizontal/vertical	Rotating laser horizontal/vertical
<b>Technical data:</b>			
Laser class	3R, 635 nm or 2, 635 nm	3R, 635 nm or 2, 635 nm	3R, 532 nm
Protection class	IP 65	IP 65	IP 65
Dual slope	-	manual	manual
AutoAlign function	-	-	-
Self-levelling range	± 5° with automatic level control	± 5° with automatic level control	± 5° with automatic level control
Levelling accuracy (horizontal/vertical)	± 1 mm/10 m	± 1 mm/10 m	± 1 mm/10 m
Accuracy (inclination)			
Remote control	-	Infrared remote control	Infrared remote control
<b>Application:</b>			
Casting concrete floors	***	***	*
Metre marking in interior work	**	**	**
Ceiling and dry wall construction	**	**	***
Use of batter boards		**	**
Bricklaying	**	***	*
Landscaping	*	*	*
Road construction	*	*	*
Interior finishing	**	***	***
Rough and fine grading	**	**	*
Depth control for excavations	***	***	*
Concrete formwork	*	*	*
Facade construction		**	*
Setting reference markers		*	

\* limited

\*\* good

\*\*\* optimal





PRIMUS <sup>2</sup> H	PRIMUS <sup>2</sup> H2N+ / PRIMUS <sup>2</sup> H2N	PRIMUS <sup>2</sup> HVA	PRIMUS <sup>2</sup> HVA2N
-----------------------	--	-------------------------	---------------------------



Rotating laser horizontal	Rotating laser horizontal Dual slope laser	Rotating laser horizontal/vertical with AutoAlign function	Rotating laser horizontal/vertical with AutoAlign function, dual slope laser
---------------------------	---	---	---

3R, 635 nm or 2, 635 nm	3R, 635 nm or 2, 635 nm	3R, 635 nm or 2, 635 nm	3R, 635 nm or 2, 635 nm
IP 66	IP 66	IP 66	IP 66
-	direct entry, tilt control H2N+	manual	direct entry with tilt control
-	-	•	•
± 5° with automatic level control	± 5° with automatic level control	± 5° with automatic level control	± 5° with automatic level control
± 0.5 mm/10 m	± 0.5 mm/10 m	± 0.5 mm/10 m	± 0.5 mm/10 m
	± 0.015% H2N+ / ± 0.1% H2N		± 0.015%
	Radio remote control	Radio remote control	Radio remote control

***	***	***	***
***	***	***	***
**	**	***	***
		***	***
**	**	***	***
*	***	**	***
*	***	**	***
**	**	**	**
**	***	**	***
**	**	***	***
*	*	***	***
		***	***
	***	*	***

**New:**

Thanks to its ingenious seal, the new **SIRIUS<sup>1</sup>** rotating laser is protected against low pressure jet water in accordance with IP 65 and therefore meets sealing requirements expected of much more expensive rotating lasers. The new rotor protection made of cast aluminium and break-proof glass means the new **SIRIUS<sup>1</sup>** is extremely robust.

The ergonomic rubber handle sits well in one's hand.

The **SIRIUS<sup>1</sup> H** and **HV** rotating lasers can optionally be supplied with laser class 2 or 3R.



## Nedo SIRIUS<sup>1</sup> H

Version	Ref.-No. laser class 3R	Ref.-No. laser class 2
SIRIUS <sup>1</sup> H	471 930	471 930-632
SIRIUS <sup>1</sup> H Set	471 931	471 931-632
SIRIUS <sup>1</sup> H with Acceptor <sup>digital</sup>	471 932	471 932-632

**New:**

**Incl. laser receiver ACCEPTOR<sup>2</sup>.**

The new **ACCEPTOR<sup>2</sup>** laser receiver has a large detector field and LCD displays on both the front and back. The multifunctional rod clamp allows it to be securely fastened to rods and batter boards without any additional accessories.

On page 73



Video **ACCEPTOR<sup>2</sup>**



**Scope of delivery SIRIUS<sup>1</sup> H:**

Rotating laser **SIRIUS<sup>1</sup> H**, laser receiver **ACCEPTOR<sup>2</sup>** with rod clamp, rechargeable batteries, charger and case

**Ref.-No. 471 930**



**SIRIUS<sup>1</sup> H Set inclusive:**

- **SIRIUS<sup>1</sup> H**
- Aluminium tripod, working range 1.02 m to 1.65 m
- Flexi Rod with universal adapter and carrying bag

**Ref.-No. 471 931**



**Scope of delivery SIRIUS<sup>1</sup> H:**

Rotating laser **SIRIUS<sup>1</sup> H**, laser receiver **ACCEPTOR<sup>2</sup> digital** with rod clamp, rechargeable batteries, charger and transport case

**Ref.-No. 471 932**

# Nedo SIRIUS<sup>1</sup> H

The fully automatic horizontal rotating laser with Easy Control – the one-push-button operation for extremely comfortable handling.

The rotating laser offers fully automatic self-levelling. The automatic level control stops the laser if it receives a heavy jolt. In this way height errors are avoided. Simply switch it on and off you go!

**Features:**

- Fully automatic horizontal laser for exterior applications
- Self-levelling range  $\pm 5^\circ$  motor-powered, with automatic level control
- High-power laser diode (3R) for very good laser beam visibility
- Alternatively available with laser class 2
- Automatic level control stops the laser if it receives a heavy jolt. In this way, height errors are avoided.
- Rugged housing protected against low pressure jet water in accordance with IP 65
- Rotor protection made of cast aluminium and break-proof glass
- High-power NiMH rechargeable batteries for long operation

**Ideal for use on every construction site. Perfect for levelling in applications such as:**

- Casting concrete floors
- Fine grading
- Metre marking in interior work
- Bricklaying
- Excavation work
- Landscaping

## Nedo SIRIUS<sup>1</sup> H

Technical data:	
Levelling accuracy	$\pm 1 \text{ mm}/10 \text{ m}$
Self-levelling range	$\pm 5^\circ$ motor-powered, with automatic level control
Working range $\emptyset$	approx. 400 m with receiver
Laser	< 5 mW, laser class 3R, 635 nm or < 1 mW laser class 2, 635 nm
Rotating speed	600 rpm
Protection class	IP 65
Power supply	NiMH rechargeable batteries 4.8 V, 3800 mAh
Operation duration	approx. 30 h
Connecting thread	5/8"



**New:**

Thanks to its ingenious seal, the new **SIRIUS<sup>1</sup>** rotating laser is protected against low pressure jet water in accordance with IP 65 and therefore meets sealing requirements expected of much more expensive rotating lasers. The new rotor protection made of cast aluminium and break-proof glass means the new **SIRIUS<sup>1</sup>** is extremely robust.

The ergonomic rubber handle sits well in one's hand.

The **SIRIUS<sup>1</sup> H** and **HV** rotating lasers can optionally be supplied with laser class 2 or 3R.



**Robust:  
Cast aluminium  
rotor protection**



**Nedo SIRIUS<sup>1</sup> HV**

Version	Ref.-No. laser class 3R	Ref.-No. laser class 2
SIRIUS <sup>1</sup> HV	471 940	471 940-632
SIRIUS <sup>1</sup> HV Set 1	471 941	471 941-632
SIRIUS <sup>1</sup> HV Set 2	471 942	471 942-632
SIRIUS <sup>1</sup> HV with ACCEPTOR <sup>digital</sup>	471 943	471 943-632
SIRIUS <sup>1</sup> HV complete set	471 944	471 944-632



**New:**

**Incl. laser receiver ACCEPTOR<sup>2</sup>.**

The new receiver ACCEPTOR<sup>2</sup> laser receiver has a large detector field and LCD displays on both the front and back. The multifunctional rod clamp allows it to be securely fastened to rods and batter boards without any additional accessories.

On page 73



**Scope of delivery SIRIUS<sup>1</sup> HV:**

Rotating laser SIRIUS<sup>1</sup> HV, laser receiver ACCEPTOR<sup>2</sup> with rod clamp, rechargeable batteries, charger, remote control and case  
Ref.-No. 471 940



**Scope of delivery SIRIUS<sup>1</sup> HV complete set:**

Rotating laser SIRIUS<sup>1</sup> HV, laser receiver ACCEPTOR<sup>2</sup> with rod clamp, target board, wall mount, vertical mount, rechargeable batteries, charger, remote control and case  
Ref.-No. 471 944



**SIRIUS<sup>1</sup> HV Set 1 inclusive:**

- SIRIUS<sup>1</sup> HV
- Elevating tripod, Ref.-No. 210 621 working range 0.80 m to 2.76 m
- Flexi Rod with universal adapter and carrying bag

**Bestell-Nr. 471 941**

**SIRIUS<sup>1</sup> HV Set 2 inclusive:**

- SIRIUS<sup>1</sup> HV
- Elevating tripod, Ref.-No. 210 616 working range 0.78 m to 2.03 m
- Flexi Rod with universal adapter and carrying bag

**Ref.-No. 471 942**

# Nedo SIRIUS<sup>1</sup> HV

The fully automatic horizontal/vertical rotating laser for clever craftsmen. It is ideal for levelling and aligning in interior outfitting and construction.

**SIRIUS<sup>1</sup> HV** combines optimum functionality, a full range of features and an attractive price-performance ratio.

**Features:**

- Fully automatic horizontal/vertical laser for interior outfitting and exterior applications
- High-power laser diode (laser class 3R) for very good laser beam visibility
- Alternatively available with laser class 2
- Automatic level control stops the laser if it receives a heavy jolt. In this way, height errors are avoided.
- Upward and downward plumb beam
- Manual setting of slopes in 2 axes
- Scanning function and dot mode
- Rugged housing protected against low pressure jet water in accordance with IP 65
- Rotor protection made of cast aluminium and break-proof glass
- High-power NiMH rechargeable batteries for long operation
- Remote control for a convenient handling

**Ideal for use on every construction site. Perfect for levelling in applications such as:**

- Casting concrete floors
- Metre marking in interior work
- Dry wall construction
- Use of batter boards
- Laying screed
- Masonry and excavation work
- Landscaping
- Interior construction

## Nedo SIRIUS<sup>1</sup> HV

Technical data:	
Levelling accuracy	± 1 mm/10 m
Self-levelling range	± 5° motor-powered, with automatic level control
Working range Ø	approx. 300 m with receiver
Laser	< 5 mW, laser class 3R, 635 nm or < 1 mW laser class 2, 635 nm
Rotating speed	0, 60, 120, 300 and 600 rpm
Scanning angle	0°, 6°, 20°, 50° and 90°
Protection class	IP 65
Power supply	NiMH rechargeable batteries 4.8 V, 3800 mAh
Operation duration	approx. 30 h
Connecting thread	5/8"

**New:**

Thanks to its ingenious seal, the new **SIRIUS<sup>1</sup>** rotating laser is protected against low pressure jet water in accordance with IP 65 and therefore meets sealing requirements expected of much more expensive rotating lasers. The new rotor protection made of cast aluminium and break-proof glass means the new **SIRIUS<sup>1</sup>** is extremely robust.

The ergonomic rubber handle sits well in one's hand.

The **SIRIUS<sup>1</sup> H** and **HV** rotating lasers can optionally be supplied with laser class 2 or 3R.



### Nedo SIRIUS<sup>1</sup> HV green

Version	Ref.-No.
SIRIUS <sup>1</sup> HV green	471 950
SIRIUS <sup>1</sup> HV green set	471 951
SIRIUS <sup>1</sup> HV complete set	471 952



## Nedo SIRIUS<sup>1</sup> HV green

The green horizontal/vertical rotating laser for optimum visibility in interior finishing.

The green laser beam guarantees optimum visibility, even under unfavourable lighting conditions. It permits working without a laser receiver even in bright daylight, with dark surfaces or over long distances.



Scope of delivery **SIRIUS<sup>1</sup> HV green**:  
Rotating laser **SIRIUS<sup>1</sup> HV green**, laser receiver **ACCEPTOR<sup>1</sup>** with rod clamp, rechargeable batteries, charger, remote control and transport case  
**Ref.-No. 471 950**



**SIRIUS<sup>1</sup> HV green** set inclusive:

- **SIRIUS<sup>1</sup> HV green**
- Elevating tripod, Ref.-No. 210 621 working range 0.80 m to 2.76 m
- Flexi Rod with universal adapter and carrying bag

**Ref.-No. 471 951**



Scope of delivery **SIRIUS<sup>1</sup> HV green complete set**:  
Rotating laser **SIRIUS<sup>1</sup> HV green**, laser receiver **ACCEPTOR<sup>1</sup>green** with rod clamp, target board, wall mount, vertical mount, rechargeable batteries, charger, remote control and transport case  
**Ref.-No. 471 952**

### Features:

- Fully automatic horizontal/vertical rotating laser for interior finishing and outdoor missions
- Green laser beam with high-power laser diode (laser class 3R) for optimum visibility, even under unfavourable lighting conditions
- Automatic level control stops the laser if it receives a heavy jolt. In this way, height errors are avoided.
- Upward and downward plumb beam
- Manual setting of slopes in 2 axes
- Scanning function and dot mode
- Rugged housing protected against low pressure jet water in accordance with IP 65
- Rotor protection made of cast aluminium and break-proof glass
- High-power NiMH rechargeable batteries for long operation
- Remote control for a convenient handling

**Ideal for interior applications. Perfect for levelling and aligning jobs, especially in the following areas:**

- Dry wall construction
- Ceiling construction
- Laying screed
- Steel construction
- Interior construction
- Installation of windows
- Installation of doors

### Nedo SIRIUS<sup>1</sup> HV green

Technical data:	
Levelling accuracy	± 1 mm/10 m
Self-levelling range	± 5° motor-powered, with automatic level control
Working range Ø	approx. 300 m with receiver
Laser	< 5 mW, laser class 3R, 532 nm
Operating temperature	0°C to +40°C
Rotating speed	0, 60, 120, 300 and 600 rpm
Scanning angle	0°, 6°, 20°, 50° and 90°
Protection class	IP 65
Power supply	rechargeable batteries NiMH 4.8 V, 3800 mAh
Operation duration	approx. 15 h
Connecting thread	5/8"



Nedo **PRIMUS<sup>2</sup>**, the series of fully automatic rotating lasers for professionals. Ideal for levelling, aligning and grade control. Reliable and rugged for tough construction jobs. Uncompromising quality for professionals. All **PRIMUS<sup>2</sup>** models can also be supplied with laser class 3R or laser class 2 with Bright Beam technology™. The **PRIMUS<sup>2</sup>** series sets a new standard for fully automatic rotating lasers. High technology made in Germany.



## The Fully Automatic Rotating Lasers Made in Germany





Included as standard:  
**PRIMUS<sup>2</sup> carefree package with**

- 3-year warranty
- Free annual check during the warranty period

**PRIMUS<sup>2</sup>**  
carefree  
package

## PRIMUS<sup>2</sup> - The Standard for Fully Automatic Rotating Lasers



### Setting Standards for Precision and Reliability

The rotating lasers in the **PRIMUS<sup>2</sup>** series remain extraordinarily precise whatever the site conditions – in continuous rainfall, severe cold or blazing heat. Whether horizontal, vertical or at a gradient.

Always reliable, whenever and wherever they are used.

The **PRIMUS<sup>2</sup>** casing is protected against jet water and dust in line with IP 66. After use, the **PRIMUS<sup>2</sup>** can even be sprayed down with water to clean it.



### The Standard for Ruggedness

Thanks to their innovative shock protection system, the rotating lasers of the **PRIMUS<sup>2</sup>** series can easily withstand a fall from a height of 1 m. The thick lining and rotor protection provide additional safety.



### Setting Standards for Visibility

All **PRIMUS<sup>2</sup>** rotating lasers are fitted with high-quality laser diodes with 635 nm wavelength. The customer can choose between high-power laser diodes in laser class 3R or laser diodes in laser class 2 featuring Bright Beam Technology™ thus ensuring optimum visibility of the laser beam even under unfavourable light conditions.

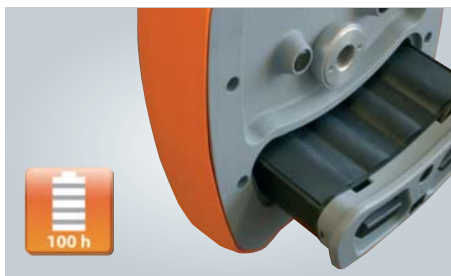

### The Standard for Long Life

High-power rechargeable NiMH batteries with Eneloop™ technology ensure a long operating life of more than 100 hours, with minimal self-discharging. The intelligent power compartment permits quick changing between battery and rechargeable battery operation.



### Setting Standards for Easy Operation

Are you fed up with difficult-to-handle devices?

All **PRIMUS<sup>2</sup>** lasers feature in addition to the standard 5/8" mounting thread the Quick-Fix rapid locking system which allows the laser device to be fixed in just a few seconds to any tripod and just as quickly detached. Just throw the lever for fixing or detaching.

That's all!

**Extremely sturdy:**

The rotating lasers in the **PRIMUS<sup>2</sup>** series conform to protection class IP 66 for use under extremely adverse working conditions.



## Nedo PRIMUS<sup>2</sup> H

	Ref.-No. laser class 3R	Ref.-No laser class 2
<b>PRIMUS<sup>2</sup> H</b> Incl. transport case, laser receiver ACCEPTOR <sup>Pro</sup> , rod clamp, Quick-Fix, rechargeable batteries and charger	472 020	472 020-632
<b>PRIMUS<sup>2</sup> H</b> Incl. transport case, Quick-Fix, rechargeable batteries and charger	472 021	472 021-632
<b>PRIMUS<sup>2</sup> H</b> Incl. transport case, laser receiver ACCEPTOR <sup>digital</sup> , rod clamp, Quick-Fix, rechargeable batteries and charger	472 022	

Supplied as standard with **ACCEPTOR<sup>pro</sup>** laser receiver with a large detector field



# Nedo PRIMUS<sup>2</sup> H

The fully automatic horizontal rotating laser

### Features:

- Fully automatic rotating laser for horizontal applications
- Robust, motor-powered levelling
- Automatic level control stops the laser if it receives a heavy jolt. In this way, height errors are avoided.
- High-power laser diode, laser class 3R, for highly visible laser beam and easy work at the close range
- Alternatively available with laser class 2 with Bright Beam Technology™
- Large, clear display showing rotation speed, battery level, etc.
- Rotor protection made of break-proof glass
- Laser receiver **ACCEPTOR<sup>pro</sup>**
- Extremely easy to use
- Highly accurate even under toughest conditions



Scope of delivery:

Rotating laser **PRIMUS<sup>2</sup> H**, laser receiver **ACCEPTOR<sup>pro</sup>** rod clamp, rechargeable batteries and charger, Quick-Fix rapid locking system and transport case

Ref.-No. 472 020

**Ideal for use on every construction site. Perfect for levelling in applications such as:**

- Rough and fine grading
- Depth control for excavations
- Casting concrete
- Bricklaying
- Landscaping



Optional accessory **"Outdoor package"**:

- Aluminium tripod, working range 1.08 m to 1.72 m
- Flexi Rod with universal adapter and carrying bag

Ref.-No. 200 350

### Nedo PRIMUS<sup>2</sup> H

Technical data:	
Levelling accuracy	± 0.5 mm/10 m
Self-levelling range	± 5° motor-powered, with automatic level control
Working range Ø	approx. 700 m with receiver ACCEPTOR <sup>pro</sup>
Laser	< 5 mW, laser class 3R, 635 nm or < 1mW, laser class 2, 635 nm
Rotating speed	600 rpm
Protection class	IP 66
Power supply	rechargeable batteries NiMH 4.8 V, 8500 mAh
Operation duration	approx. 100 h
Connecting thread	5/8"



**Dual slope function**  
For horizontal use and for slopes in one or two axes

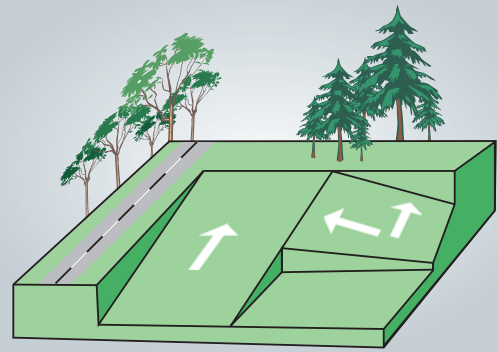

## Nedo PRIMUS<sup>2</sup> H2N+ / PRIMUS<sup>2</sup> H2N

	Ref.-No. laser class 3R	Ref.-No. laser class 2
<b>PRIMUS<sup>2</sup> H2N+ with tilt control</b> Incl. multi-function module COMMANDER <sup>2</sup> H2N+ (laser receiver incl. radio remote control), rod clamp, Quick-Fix, rechargeable batteries, charger and transport case	<b>472 034</b>	<b>472 034-632</b>
<b>PRIMUS<sup>2</sup> H2N+ with tilt control</b> Incl. laser receiver ACCEPTOR <sup>digital</sup> , rod clamp, Quick-Fix, rechargeable batteries, charger and transport case	<b>472 035</b>	<b>472 035-632</b>
<b>PRIMUS<sup>2</sup> H2N+ with tilt control</b> Incl. Quick-Fix, rechargeable batteries, charger and transport case	<b>472 033</b>	<b>472 033-632</b>
<b>PRIMUS<sup>2</sup> H2N</b> Incl. transport case, rechargeable batteries and charger	<b>472 030</b>	<b>472 030-632</b>
<b>PRIMUS<sup>2</sup> H2N</b> Incl. multi-function module COMMANDER <sup>2</sup> H2N (laser receiver incl. radio remote control), rod clamp, Quick-Fix, rechargeable batteries, charger and transport case	<b>472 031</b>	<b>472 031-632</b>
<b>PRIMUS<sup>2</sup> H2N</b> Incl. laser receiver ACCEPTOR <sup>digital</sup> , rod clamp, rechargeable batteries, charger and transport case	<b>472 032</b>	<b>472 032-632</b>



Optional accessory:  
Telescopic sight with laser sighting  
mechanism  
Ref.-No. 461 096



## Nedo PRIMUS<sup>2</sup> H2N+

Fully automatic dual slope laser with tilt control and automatic re-levelling when in slope mode

## Nedo PRIMUS<sup>2</sup> H2N

Fully automatic dual slope laser

### Features:

- Fully automatic dual slope laser
- Robust, motor-powered levelling
- Direct grade entry for the x and y axes
- Slope values once input are stored upon switch-off
- **PRIMUS<sup>2</sup> H2N+** with tilt control: the position of the laser plane is continuously monitored in the slope mode and re-levelled if necessary.
- Automatic level control stops the laser if it receives a heavy jolt. In this way, height errors are avoided.
- Large, clear display showing inclination, rotation speed, battery level, etc.
- High-Power laser diode, laser class 3R, for highly visible laser beam and easy work at the close range
- Alternatively available with laser class 2 with Bright Beam Technology™
- Rotor protection made of break-proof glass
- Highly accurate even under toughest conditions



Scope of delivery:  
Rotating laser **PRIMUS<sup>2</sup> H2N**, laser receiver **COMMANDER<sup>2</sup> H2N** with rod clamp, rechargeable batteries, charger, Quick-Fix rapid locking system and transport case  
Ref.-No. 472 031

### Ideal for use on every construction site. Perfect for levelling in applications such as:

- Elevation control
- Rough and fine grading
- Depth control for excavations
- Machine control
- Casting concrete
- Bricklaying
- Setting foundations and footings
- Landscaping

### Nedo PRIMUS<sup>2</sup> H2N+ and H2N

Technical data:	
Levelling accuracy	± 0.5 mm/10 m
Self-levelling range	± 5° motor-powered, with automatic level control
Accuracy of the slope function	± 0.015% PRIMUS <sup>2</sup> H2N+, ± 0.1% PRIMUS <sup>2</sup> H2N
Working range Ø	approx. 700 m with receiver COMMANDER <sup>2</sup> H2N
Laser	< 5 mW, laser class 3R, 635 nm < 1mW, laser class 2, 635 nm
Rotating speed	600 rpm
Protection class	IP 66
Power supply	rechargeable batteries NiMH 4.8 V, 8500 mAh
Operation duration	approx. 100 h
Connecting thread	5/8"



Optional accessory "Outdoor package":

- Aluminium tripod, working range 1.08 m to 1.72 m
- Flexi Rod with universal adapter and carrying bag

Ref.-No. 200 350



AutoAlign Video

### AutoAlign function

At the push of a button, the laser plane automatically aligns with the laser receiver **COMMANDER<sup>2</sup> HVA**. Ideal when batter boards are used or on facade construction.

The working range of the AutoAlign function is 50 metres.



## Nedo PRIMUS<sup>2</sup> HVA

	Ref.-No. laser class 3R	Ref.-No. laser class 2
<b>PRIMUS<sup>2</sup> HVA</b>	<b>472 050</b>	<b>472 050-632</b>

Incl. multi-function module **COMMANDER<sup>2</sup> HVA** (laser receiver incl. radio remote control), rod clamp, magnetic target board, Quick-Fix, rechargeable batteries, charger and transport case

The AutoAlign function eliminates the need for tiresome manual alignment of the laser plane on the laser receiver, saving considerable time when batter boards are used and in facade construction. Batter board and facade construction adapters are available as optional accessories for the **PRIMUS<sup>2</sup>** and the **COMMANDER<sup>2</sup>** laser receiver.



## Nedo PRIMUS<sup>2</sup> HVA

The fully automatic horizontal/vertical rotating laser with AutoAlign function



Scope of delivery:

Rotating laser **PRIMUS<sup>2</sup> HVA**, laser receiver **COMMANDER<sup>2</sup> HVA** with rod clamp, magnetic target board, rechargeable batteries, charger, Quick-Fix rapid locking system and transport case

Ref.-No. 472 050



Supplied as standard with **COMMANDER<sup>2</sup> HVA** laser receiver with integrated remote control

### Features:

- Fully automatic rotating laser for horizontal and vertical applications
- AutoAlign function: automatic alignment of the laser beam to the zero mark of the laser receiver
- Robust motor-powered levelling
- Large, clear display showing rotation speed, battery level, etc.
- Automatic level control stops the laser if it receives a heavy jolt. In this way, height errors are avoided.
- Manual setting of slopes in 2 axes
- Scan function and dot mode
- High-Power laser diode, laser class 3R, for highly visible laser beam and easy work at the close range
- Alternatively available with laser class 2 with Bright Beam Technology™
- Upward plumb beam
- Rotor protection made of break-proof glass
- Highly accurate even under toughest conditions
- Radio remote control for a convenient handling

**Ideal for interior applications. Perfect for levelling and aligning jobs, especially in the following areas:**

- Depth control for excavations
- Concrete casting
- Concrete formwork
- Use of batter boards
- Bricklaying
- Laying screed
- Drywall installation
- Ceiling construction
- Facade construction

### Nedo PRIMUS<sup>2</sup> HVA

Technical data:	
Levelling accuracy	± 0.5 mm/10 m
Self-levelling range	± 5° motor-powered, with automatic level control
Setting of slopes in two axes	manual
Working range Ø	approx. 500 m with receiver <b>COMMANDER<sup>2</sup> HVA</b>
Laser	< 5 mW, laser class 3R, 635 nm or < 1mW, laser class 2, 635 nm
Working range radio remote control	approx. 150 m
Working range AutoAlign	approx. 50 m
Rotating speed	10, 60, 300 and 600 rpm
Scanning angle	0°, 5°, 10° and 15°
Protection class	IP 66
Power supply	rechargeable batteries NiMH 4.8 V, 8500 mAh
Operation duration	approx. 100 h
Connecting thread	5/8"



Optional accessory "Accessory package 1":

- Elevating tripod, working range 0.80 m to 2.76 m
- Flexi Rod with universal adapter and carrying bag

Ref.-No. 210 350

Optional accessory "Accessory package 2":

- Elevating tripod, working range 0.78 m to 2.03 m
- Flexi Rod with universal adapter and carrying bag

Ref.-No. 210 351





AutoAlign Video

### AutoAlign function

At the push of a button, the laser plane automatically aligns with the laser receiver **COMMANDER<sup>2</sup> HVA2N**. Ideal when batter boards are used or on facade construction.

The working range of the AutoAlign function is 50 metres.



## Nedo PRIMUS<sup>2</sup> HVA2N

	Ref.-No. laser class 3R	Ref.-No. laser class 2
--	-------------------------	------------------------

**PRIMUS<sup>2</sup> HVA2N**

**472 061**

**472 061-632**

Incl. magnetic target board, multi-function module **COMMANDER<sup>2</sup> HVA2N** (laser receiver incl. radio remote control) and rod clamp, Quick-Fix, rechargeable batteries, charger and transport case



### Dual slope function

For horizontal use and for slopes in one or two axes.  
Tilt monitoring and automatic re-levelling when in slope mode.

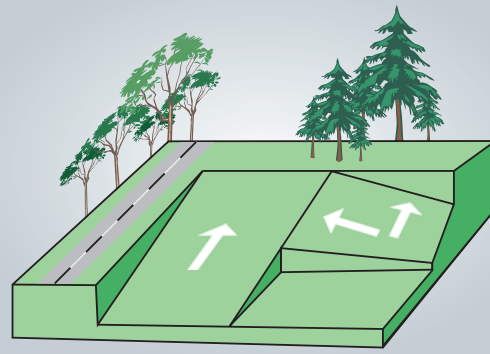

# Nedo PRIMUS<sup>2</sup> HVA2N

The fully automatic horizontal/vertical dual slope laser with AutoAlign function

### Features:

- Fully automatic rotating laser for horizontal and vertical applications
- Direct grade entry for the x and y axis
- Tilt control: the position of the laser is continuously monitored in the tilt mode
- AutoAlign function: automatic alignment of the laser beam to the zero mark of the laser receiver
- Robust motor-powered levelling
- Large, clear display showing inclination, rotation speed, battery level, etc.
- Automatic level control stops the laser if it receives a heavy jolt. In this way, height errors are avoided.
- High-Power laser diode, laser class 3R, for highly visible laser beam and easy work at the close range
- Alternatively available with laser class 2 with Bright Beam Technology™
- Scan function and dot mode
- Upward plumb beam
- Rotor protection made of break-proof glass
- Highly accurate even under toughest conditions
- Radio remote control for a convenient handling



Scope of delivery:

Rotating laser **PRIMUS<sup>2</sup> HVA2N**, laser receiver **COMMANDER<sup>2</sup> HVA2N** with rod clamp, magnetic target board, rechargeable batteries, charger, Quick-Fix rapid locking system and transport case

Ref.-No. 472 061

**Ideal for use on every construction site. Perfect for levelling in applications such as:**

- Depth control for excavations
- Concrete casting
- Setting foundations and footings
- Concrete casting
- Use of batter boards
- Bricklaying
- Landscaping
- Laying screed
- Facade construction
- Setting reference markers
- Rough and fine grading
- Ceiling construction

## Nedo PRIMUS<sup>2</sup> HVA2N

Technical data:	
Levelling accuracy	± 0.5 mm/10 m
Self-levelling range	± 5° motor-powered, with automatic level control
Accuracy of the slope function	± 0.015%
Setting of slopes in two axes	± 10%, direct entry
Working range Ø	approx. 700 m with receiver <b>COMMANDER<sup>2</sup> HVA2N</b>
Laser	< 5 mW, laser class 3R, 635 nm or < 1mW, laser class 2, 635 nm
Working range radio remote control	approx. 150 m
Working range AutoAlign	approx. 50 m
Rotating speed	10, 60, 300 and 600 rpm
Scanning angle	0°, 5°, 10° and 15°
Protection class	IP 66
Power supply	rechargeable batteries NiMH 4.8 V, 8500 mAh
Operation duration	approx. 100 h
Connecting thread	5/8"



Optional accessory "Accessory package 1":

- Elevating tripod, working range 0.80 m to 2.76 m
- Flexi Rod with universal adapter and carrying bag

Ref.-No. 210 350

Optional accessory "Accessory package 2":

- Elevating tripod, working range 0.78 m to 2.03 m
- Flexi Rod with universal adapter and carrying bag

Ref.-No. 210 351

Extremely sturdy.  
Uncompromising quality for professionals.



Extremely compact.  
Thanks to its short length the pipe laser can even be used in tight pipe bends.



# Nedo Pipe Laser TUBUS<sup>1</sup>

Uncompromising quality for professionals, reliable and rugged for tough construction jobs.

Thanks to its compact dimensions, in particular its short length, **TUBUS<sup>1</sup>** can even be used in tight pipe bends. The high-power laser diode provides a long range and ensures clear beam visibility at any time.



Scope of delivery **TUBUS<sup>1</sup>**:  
Pipe laser **TUBUS<sup>1</sup>**, remote control, rechargeable batteries, charger, set of feet, adjustable in height target board and transport case  
**Ref.-No. 472 200**

## Features:

- Extremely robust pipe laser with full-metal housing
- Compact dimensions for use in tight pipe bends
- Reliable motor-powered levelling
- Direct grade entry: - 10 % to + 40 %
- Including a set of 4 feet for easy adjustment to different pipe diameters
- Aid for simple axis alignment
- Perfect visualisation of operation mode: Green display for rising gradients, red display for falling gradients
- Remote control for easy and convenient handling
- Red high-power laser diode for very good beam visibility
- Rechargeable lithium-ion batteries for long operating life and quick charging

**Ideal for use on every construction site. Perfect for levelling in applications such as:**

- Sewer construction
- Laying gravity flow pipes
- Installation of drainage systems
- Laying of supply pipes

## Nedo TUBUS<sup>1</sup>

Ref.-No.	472 200
Levelling accuracy	± 5 mm/100 m
Self-levelling range	-15 % to +45 %
Gradient range	-10 % to +40 %
Display resolution	0,001 %
Laser	max. 5 mW, laser class 3R, 635 nm
Operating temperature	-20°C to +50°C
Protection class	IP 68
Operation duration	approx. 40 h
Weight	approx. 3.5 kg
Dimension	ø 140 mm, length 300 mm



Optional accessory:  
Laser protection glasses for laser class 3R  
**Ref.-No. 460 909**





## Nedo Laser Receiver for Rotating Lasers

### ACCEPTOR<sup>pro</sup>



#### Features:

- Extremely robust laser receiver
- Large detector field with 70 mm length
- Large LC display on front and back
- Jet water-proof and dust-proof to IP 66
- Bright LED display
- Adjustable volume
- Display of remaining battery power
- Easy to handle
- Rod clamp for laser receiver

Ref.-No. 430 372

#### Technical data:

- Accuracy: switchable,  $\pm 0.5$  mm,  $\pm 1.0$  mm,  $\pm 2.0$  mm,  $\pm 4.0$  mm
- Length of detector field: 70 mm
- Working range:  $\varnothing$  700 m (depends on laser)
- Protection class IP 66
- Operating temperature:  $-20^{\circ}\text{C}$  to  $+50^{\circ}\text{C}$
- Power supply: 3 x 1.5 V batteries (AA) or rechargeable batteries (NiMH)
- Operation duration: approx. 100 h

### COMMANDER<sup>2</sup>



#### Features:

- Laser receiver with integrated radio remote control
- Large LC display on front and back
- Plain-language LCD display showing all the data of the PRIMUS<sup>2</sup> displays
- Jet water-proof and dust-proof to IP 66
- Bright LED display
- Adjustable volume
- Large detector field with 70 mm length
- Display of remaining battery power
- Extremely robust
- Easy to handle
- Rod clamp for laser receiver

Ref.-No. 430 371 COMMANDER<sup>2</sup> H2N  
Ref.-No. 430 374 COMMANDER<sup>2</sup> H2N+

#### Technical data:

- Accuracy: switchable,  $\pm 0.5$  mm,  $\pm 1.0$  mm,  $\pm 2.0$  mm,  $\pm 4.0$  mm
- Length of detector field: 70 mm
- Working range:  $\varnothing$  700 m (depends on laser)
- Protection class IP 66
- Operating temperature:  $-20^{\circ}\text{C}$  to  $+50^{\circ}\text{C}$
- Power supply: 3 x 1.5 V batteries (AA) or rechargeable batteries (NiMH)
- Operation duration: approx. 100 h





The multifunctional rod clamp allows the laser receiver to be securely fastened to rods and batter boards without any additional accessories.



Thanks to its patented design the **ACCEPTOR<sup>2</sup>** laser receiver can be placed flat against the wall with a screwed-on rod clamp to mark the laser level. The continuous edge and flat contact surface ensure more accurate results.

## ACCEPTOR<sup>2</sup>



Video ACCEPTOR<sup>2</sup>

### Features:

- Extremely robust laser receiver
- Large detector field: 50 mm
- Large LC display on front and back
- Bright LED display
- Adjustable volume
- Display of remaining battery power
- Strong magnets for fixing to steel girders
- Protected against powerful jet water to IP 67
- Two accuracy modes: coarse and fine
- Bubble for easy alignment
- Multifunctional rod clamp with patented quick clamp and batter board function
- Vertical attachment for around-the-corner applications
- Stop blade for wood measuring aids

Ref.-No. 430 333

### Technical data:

- Accuracy: switchable,  $\pm 4.0$  mm/ $\pm 1.0$  mm
- Working range:  $\varnothing$  550 m (depends on laser)
- Protection class IP 67
- Power supply: 2 x 1.5 V (AA)
- Operation duration: approx. 120 h (batteries)  
approx. 100 h (rechargeable batteries)

## ACCEPTOR<sup>digital</sup>



### Features:

- Large LC display on front and back
- Displays height difference between laser level and zero line in mm
- 2 different zero positions can be selected
- Size of directional arrow is proportional to difference in height
- Protected against powerful jet water to IP 67
- Features an extra large 127 mm detector field
- Hold function keeps a value on the display
- Automatic switch-off
- Display of remaining battery power
- Bubble for easy alignment
- Rod clamp for laser receiver

Ref.-No. 430 328

### Technical data:

- Accuracy:  $\pm 0.5$  mm,  $\pm 1.0$  mm,  $\pm 2.0$  mm,  $\pm 5.0$  mm,  $\pm 10$  mm
- Working range: 450 m (depends on laser)
- Protection class IP 67
- Power supply: 2 x 1.5 V type mignon (AA)
- Operation duration: approx. 60 h



## Nedo Facade Construction Adapters

The Facade Construction Adapters are fastened to the wall and horizontally aligned with the aid of integrated bubbles. Thanks to the mm graduations provided on the traverses, rotating lasers and laser receivers can be conveniently positioned at the required distance from the wall. The new Facade Construction Adapters have been optimally matched to the fully automatic PRIMUS<sup>2</sup> HVA rotating laser with AutoAlign function and to the COMMANDER<sup>2</sup> laser receiver, and provide in combination with these instruments a professional and complete system for facade construction.

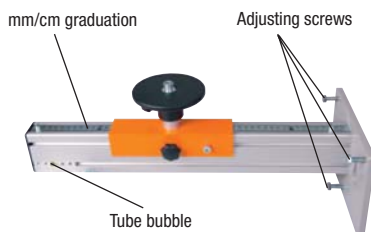

### Facade Construction Adapter for PRIMUS<sup>2</sup> Rotating Lasers

Sturdy aluminium facade construction adapter. Sliding runner with tripod head and 5/8" connecting thread. Adjusting range approx. 450 mm. Three adjusting screws allow exact alignment of the facade construction adapter.

**Ref.-No. 461 046**

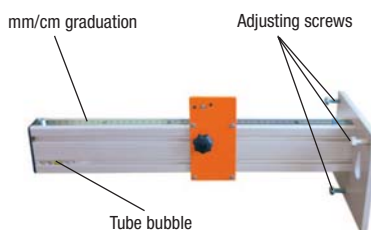

### Facade Construction Adapter for COMMANDER<sup>2</sup> Laser Receivers

Sturdy aluminium facade construction adapter. Sliding runner for accommodating the COMMANDER<sup>2</sup> laser receiver. Adjusting range approx. 490 mm. Three adjusting screws allow exact alignment of the facade construction adapter.

**Ref.-No. 461 056**

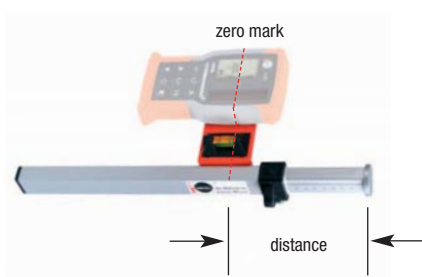

### Mini-Flexi Rod for Facade Construction

The mini-flexi rod allows distances in facade construction to be measured quickly and easily. Measurement range: 65 mm to 280 mm

**Ref.-No. 461 048**





## Nedo Batter Board Holder

On modern construction sites the batter board is increasingly being supplanted by a rotating laser. The laser is, in vertical operation, placed on a batter board holder fastened to the batter board by a clamping screw. The batter board holder is provided with a turntable allowing rough alignment of the rotating laser.

The laser receiver with the receiver holder is clamped on the opposite side of the batter board. Thanks to the AutoAlign function, the laser plane automatically aligns with the laser receiver in the case of the PRIMUS<sup>2</sup> HVA and PRIMUS<sup>2</sup> HVA2N models. Furthermore, the laser plane is automatically monitored and if necessary corrected by the AutoAlign function.



### Batter Board Holder for Rotating Lasers PRIMUS<sup>2</sup>

Sturdy aluminium batter board holder with four clamping screws. Suitable for use with rotating lasers from the PRIMUS<sup>2</sup> series.

**Ref.-No. 461 051**



### Batter Board Holder for Laser Receiver COMMANDER<sup>2</sup>

Sturdy aluminium batter board holder with one clamping screw. Suitable for use with COMMANDER<sup>2</sup> laser receiver.

**Ref.-No. 461 055**





## Nedo Laser Accessories



### Wall Mount ECO

Robust wall mount for line and dot lasers. Can be attached to the wall or to ceiling construction profiles.

Adjustable range: 100 mm

Ref.-No. 461 032-613



### Wall Mount »easy«

Robust wall mount for all rotating lasers. Can be attached to the wall with two screws.

Adjustable range: 55 mm

Ref.-No. 461 030



### Vertical Mount »easy«

For vertical use of the SIRIUS<sup>1</sup> HV or SIRIUS<sup>1</sup> HV green with a tripod.

Ref.-No. 461 031



### Wall Mount-S

Robust wall mount for all rotating lasers. Can be attached to the wall or to ceiling construction profiles. Fine adjustment allows heights to be easily reset. Perfect for suspended ceilings. Adjustable range: 150 mm.

The Wall Mount-S can be fixed horizontally to a 5/8" thread tripod. Ideal for exact alignment of the laser in the structural facing sector.

Ref.-No. 461 020







# Nedo Accessories PRIMUS<sup>2</sup>

## Telescopic Sight



The use of dual-axis slope lasers requires an extremely exact alignment of the laser axes. With the help of the **PRIMUS<sup>2</sup>** telescopic sight with integrated target laser the laser axis can be precisely aligned to the target even if it is a great distance away. The telescopic sight can easily be fixed to the **PRIMUS<sup>2</sup>** without any tools. Suitable for use with the dual slope lasers **PRIMUS<sup>2</sup> H2N, H2N+** and **HVA2N**.

**Ref.-No. 461 096**

## PRIMUS<sup>2</sup> Battery Charger Add-On Kit



Spare battery and charger, can be used for all PRIMUS<sup>2</sup> models.

**Ref.-No. 461 098**

## PRIMUS<sup>2</sup> Battery Box

Battery box for 4 x 1.5 V mono-cells, can be used for all PRIMUS<sup>2</sup> models.

**Ref.-No. 461 097**

## Outdoor Package for PRIMUS<sup>2</sup> Series



- Aluminium tripod, working range 1.08 to 1.72 m Ref.-No. 200 200
- Flexi Rod with universal adapter and carrying bag

**Ref.-No. 200 350**



## Accessory Package 1 for PRIMUS<sup>2</sup> Series



- Elevating tripod, working range 0.80 m to 2.76 m Ref.-No. 210 621
- Flexi Rod with universal adapter and carrying bag

**Ref.-No. 210 350**



## Accessory Package 2 for PRIMUS<sup>2</sup> Series



- Elevating tripod, working range 0.78 m to 2.03 m Ref.-No. 210 616
- Flexi Rod with universal adapter and carrying bag

**Ref.-No. 210 351**



## PRIMUS<sup>2</sup> Tripod



Sturdy aluminium tripod with integrated Quick-Fix locking system.

### Technical data:

- Min. effective height: approx. 1.07 m
- Max. effective height: approx. 1.71 m
- Retracted length: approx. 1.15 m
- Weight: approx. 5.00 kg
- Tripod head Quick-Fix, ø 140 mm

**Ref.-No. 200 202**



# Nedo Tilt Adapter

With the tilt adapter, inclines of up to 90° can be set manually. Quick adjustment with 6 stages and additional fine adjustment. Scale with % and ° units. Ideal for creating slopes or refurbishing roofs.

Incl. circular level, built-in sighting device, 5/8" connecting thread and Quick-Fix system.



## Features:

- Accuracy:  $\pm 1^\circ$
- Coarse and fine adjustment for quick height settings
- Integrated Quick-Fix system for all lasers in the PRIMUS<sup>2</sup> series
- 5/8" thread for all rotating lasers
- Scale with degree and percent graduations
- Made of high-quality cast aluminium

Ref.-No. 461 047

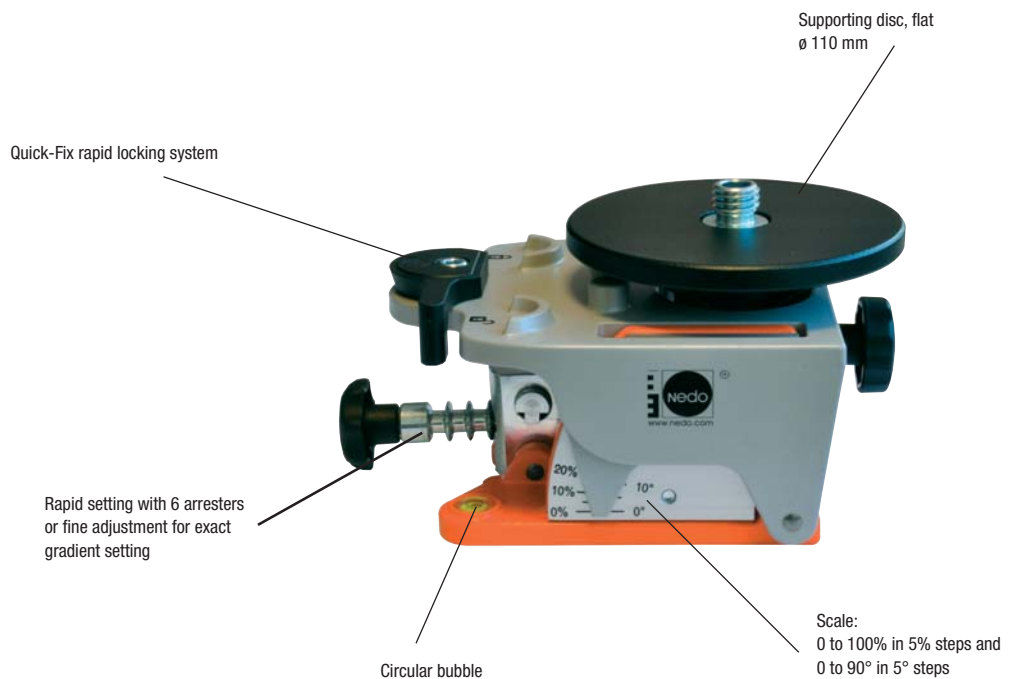



## Nedo Flexi Rods

Simply read off the direct reading scale.

When levelling with a rotating laser, the Flexi Rod is the ideal accessory for determining differences in heights quickly, exactly and correctly signed.



Set incl. adapter and bag

Ref.-No. 360 916-622

### Features:

- Robust Flexi Rod made of anodised aluminium tubes
- Abrasion-resistant graduation
- Bubble for vertical alignment of the Flexi Rod
- Robust clamping screw to securely lock the extension
- Also available as a set including adapter and case



Ref.-No. 365 111



Ref.-No.  
360 515-613



Ref.-No.  
360 511



Ref.-No.  
360 912



Ref.-No.  
365 112-613

### Nedo Flexi Rods

Ref.-No.	Scope of delivery
360 811-622	Flexi Rod with circular bubble, length 1.31 m - 2.42 m
360 916-622	Flexi Rod set incl. universal adapter with quick clamp and bag

### Adapters and accessories

Ref.-No.	
360 515-613	Universal adapter with quick clamp made of metal
360 511	Plastic universal adapter
360 912	Slide with target board for dot lasers
365 112-613	Bag for all Flexi Rods
365 111	Base plate for casting concrete



## Nedo Laser mEssfix-S

Nedo **Laser mEssfix-S** is a robust telescopic measuring stick for determining differences in height with a rotating laser and a laser receiver. Perfect for use in excavation jobs, levelling and civil engineering projects.

Simply attach the laser receiver to the **Laser mEssfix-S** and position the detector in the laser plane by means of telescopic sections. The height of the laser plane can be read off from the analogue display.

Quick, simple and precise.

The universal adapter allows to attach all kinds of laser receivers to the **Laser mEssfix-S**. In order to avoid unintentional changes in the extended length, the telescopes are equipped with a clamping screw to ensure a secure hold. The vertical position is maintained thanks to the circular bubble.

### Features:

- Robust telescopic measuring stick with easy-to-read analogue display
- Universal adapter to accommodate all types of laser receivers
- Circular bubble to ensure an exact alignment
- Anodised telescopes, can be fixed with clamping screws
- Easy to handle
- Reliable levelling system for all rotating lasers with receiver



### Nedo Laser mEssfix-S

Ref.-No.	Features	Min. length	Max. length
F 687 511	with universal adapter	1.37 m	5.17 m
F 887 511	with universal adapter	1.70 m	6.83 m



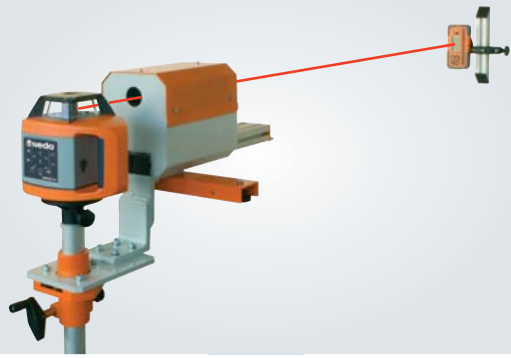

## Nedo Laser Calibration<sup>1</sup>

The **Laser Calibration<sup>1</sup>** is used for monitoring and adjusting the horizontal laser plane of a rotating laser with a red laser beam. The system operates according to the reversal measurement principle, in this way permitting deviations of the laser plane from the horizontal to be measured for both axes. The system contains a digital laser receiver (ACCEPTOR<sup>digital</sup>) for detecting the laser plane. Intermediate results of the reversal measurements are entered in an Excel spreadsheet which then calculates the final result (deviation of the laser plane from the horizontal). This inexpensive system is perfect for small service and repair workshops.



### Features:

- Simple device for monitoring and adjusting the horizontal accuracy of rotating lasers with a red laser beam
- Measurement principle: reversal measurement
- Ideal for small service and repair workshops or construction equipment leasing companies

### Nedo Laser Calibration<sup>1</sup>

Ref.-No.	461 099
Dimensions	713 x 400 x 702 mm
Weight	approx. 21 kg
Accuracy	± 0.1 mm/m
Resolution	± 0.02 mm/m
Suitable for rotating lasers	laser class 2 ... 3R, 635 nm

## Nedo Laser Calibration<sup>2</sup>

The **Laser Calibration<sup>2</sup>** is a professional, PC-based system for monitoring and adjusting the horizontal laser plane of red and green rotating lasers. It uses state-of-the-art image processing for quick and inexpensive monitoring and adjustment. The system can automatically generate, archive and print out test records. These records can be individually designed and tailored to the needs of the service shop. An easy-to-use Windows interface is provided for operation. Professional service shops will appreciate its highly compact design and encapsulation of the system in a sturdy housing. The **Laser Calibration<sup>2</sup>** can be integrated into a computer network, where it is well prepared for future expansion and accessible for remote maintenance by Nedo.

Complete system, including PC, software and hardware.



### Features:

- Professional, PC-based system for monitoring and adjusting the horizontal accuracy of rotating lasers
- For red and green lasers
- Measurement principle: state-of-the-art image processing
- Professional adjustment system for service and repair workshops that emphasise cost-effectiveness
- Network-capable
- Remote maintenance by Nedo possible
- Print-outs of personalised test records possible

### Nedo Laser Calibration<sup>2</sup>

<b>Ref.-No.</b>	<b>461 100</b>
Dimensions	1082 mm x 400 mm x 888 mm
Weight	25.5 kg
Accuracy	± 0.1 mm/m (20")
Resolution	± 0.051 mm/m (2")
Suitable for rotating lasers	laser class 2 ... 3R, 532 - 635 nm

# Laser Calibration<sup>2</sup>

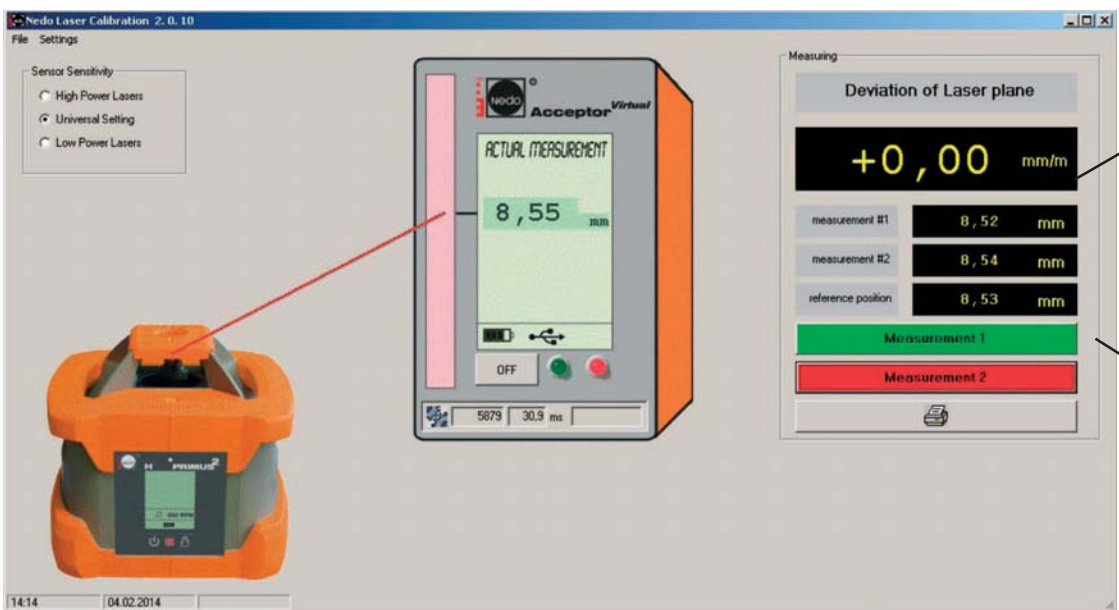

Direct reading of the accuracy of the rotating laser

Easy-to-use interface



Tailoring of software to the service shop



Personalised test records



Archiving in PDF format

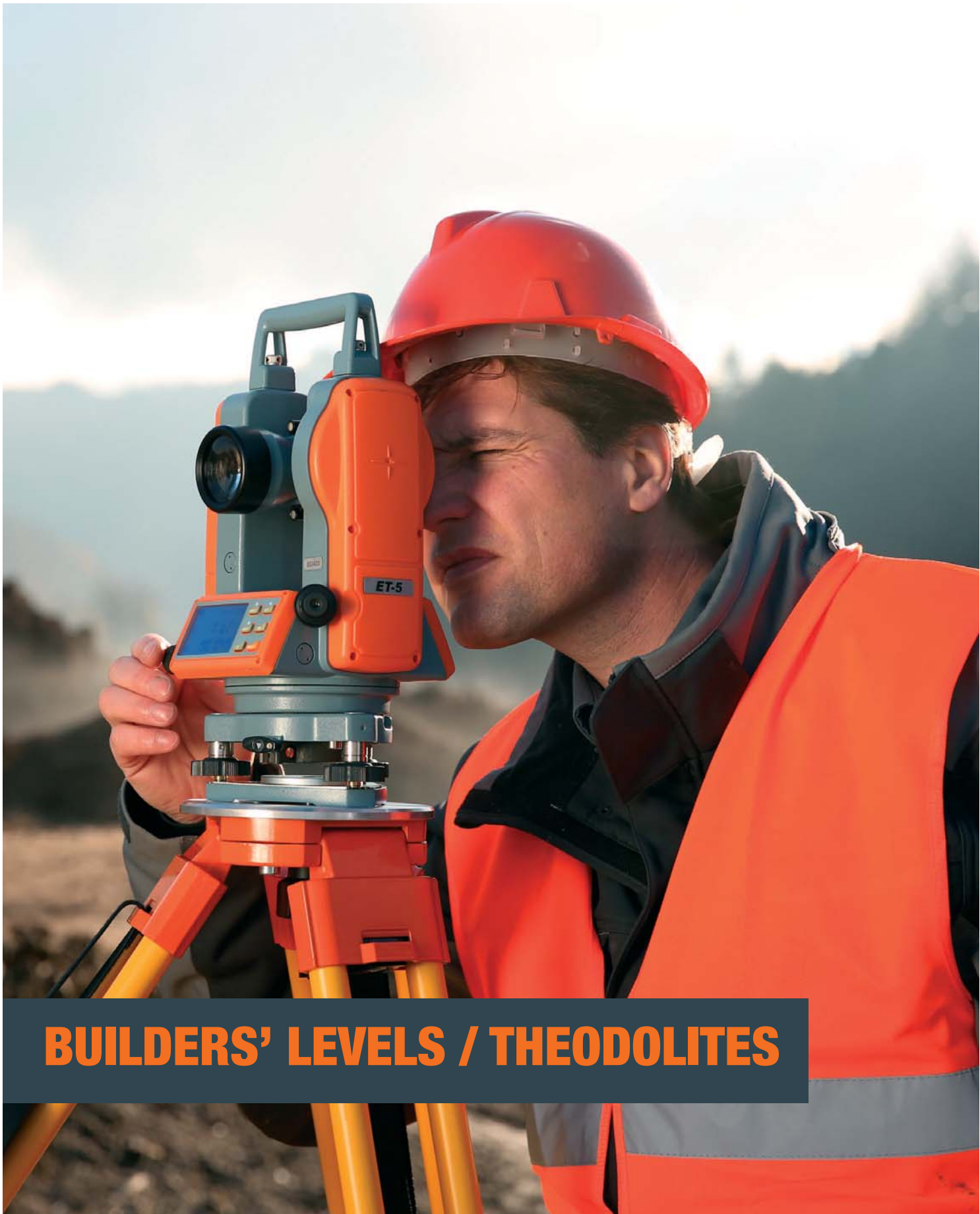

## **BUILDERS' LEVELS / THEODOLITES**



---

## Focus on Precision

Nedo offers an attractive range of optical surveying instruments.

In order to meet differing needs in terms of robustness and accuracy, Nedo has three different level series with different magnifications. All Nedo levels have high-quality optical systems with plenty of light-gathering power.

Our electronic theodolites are optionally available with an optical plummet or a laser plummet.

Each Nedo surveying instrument is thoroughly inspected and precisely adjusted before shipment, and each comes with a test report.





## The Principles of Optics

The magnification of an optical instrument indicates how much closer a target appears to the user when looking through the instrument compared when looking to the target without instrument. The larger the magnification is chosen, the smaller the field of vision and the light intensity get. The objective aperture also has a great influence on the light intensity. The larger the objective aperture, the better is the light intensity of the object, i.e. the brighter the image.



## Automatic Levels

Levelling instruments are used to create a horizontal line of sight in order to determine differences in height. The main components include a telescope with crosshair which can rotate around the vertical axis, a horizontal circle for marking off the angles, and the bubble which helps to keep the instrument in a horizontal position with a tribrach. Automatic levels also feature a compensator mechanism which will adjust the level to an exactly horizontal position within a small working range. The compensators are equipped with a damping system. In practice, air-damped and magnetically damped compensators have become generally accepted. The air-damped compensators are of better quality whereas magnetically damped compensators are more favourably priced.



## Theodolites

A theodolite is an instrument used for precise measurements of vertical and horizontal angles. On construction sites, theodolites are further used for making exact alignments, e.g. when foundations are cast and for checking if formwork and facades are perfectly vertical. The precision of a theodolite is given in arcseconds. Electronic theodolites with digital displays have become generally accepted as they provide easy read-offs.



## Selecting the Right Nedo Levelling Instrument

Nedo offers a range of various automatic levelling instruments:

- **F Series:** State-of-the-art builders' levels with powerful optical systems. Sturdy and reliable for tough jobs on construction sites.
- **X Series:** Premium builders' levels that meet the highest quality standards.
- **Z Series:** Engineers' levels that meet the highest quality standards. Protected against dust and jet water as per IP X6.

Each Nedo levelling instrument is carefully checked and adjusted before dispatch. All Nedo automatic levels are accompanied by an inspection record as part of the scope of delivery.

## Selecting the Right Magnification

As a rule of thumb, the magnification should be the target distance in metres. Levels with a 24x magnification are ideal for applications on the construction site. An interesting alternative from the aspect of cost is a level with a 20x magnification. Levels with a 28x or 32x magnification are used mainly for engineering and surveying purposes.

	Working environment		
	tough	extremely tough	extremely tough/moist environment
<b>Builders' Levels F-Series</b>	✓		
<b>Builders' Levels X-Series</b>	✓	✓	
<b>Engineers' Levels Z-Series</b>	✓	✓	✓



**Levelling set with F-level consisting of:**

- 5 m levelling staff and bag No. 345 122-613
- Aluminium tripod No. 200 215-613

## Nedo Builders' Levels F-Series

The **F-levels** feature first-class optics with 24x, 28x or 32x magnification, a top-quality magnetic-damped compensator and a modern design. Just right for use under tough conditions.

**Features:**

- Automatic builders' level with 24x, 28x or 32x magnification
- Bright optics with large objective aperture
- Sturdy, reliable magnetic-damped compensator
- Rugged metal housing
- High-contrast image
- Inspection record
- Comes with plumb bob, adjusting pin and robust case
- Also available as a set

### Nedo Builders' Levels F-Series

	F24	F28	F32
<b>Ref.-No.</b> (horizontal circle gon)	460 777-613	460 795-613	460 797-613
<b>Ref.-No.</b> (horizontal circle degrees)	460 778-613	460 796-613	460 798-613
<b>Ref.-No. Set</b> (horizontal circle gon)	463 105	465 105	466 105
Image	upright	upright	upright
Magnification	24x	28x	32x
Clear objective aperture	30 mm	30 mm	40 mm
Shortest focusing distance	0.6 m	0.6 m	0.6 m
Multiplication factor	100	100	100
Compensator operating range	± 15'	± 15'	± 15'
Setting accuracy	± 0.5"	± 0.3"	± 0.3"
Horizontal circle	400 gon / degrees	400 gon / degrees	400 gon / degrees
Sensitivity of circular bubble	8'/2 mm	8'/2 mm	8'/2 mm
Standard deviation per km double-run levelling	± 2.5 mm	± 2.0 mm	± 1.5 mm
Protection class	IP 54	IP 54	IP 54
Weight	1.26 kg	1.26 kg	1.26 kg
Connecting thread	5/8"	5/8"	5/8"





**Levelling set with X-level consisting of:**

- 5 m levelling staff and bag No. 345 122-613
- Aluminium tripod No. 200 215-613

## Nedo Builders' Levels X-Series

Nedo **X-levels** are top-quality builders' levels which meet the very highest demands. These builders' levels feature particularly bright optics, a large objective aperture, a sturdy air-damped compensator and quality workmanship – just right for use under eXtremely tough conditions.

**Features:**

- Automatic builders' level with 20x, 24x, 28x and 32x magnification
- Bright optics with large objective aperture
- Rugged metal housing
- Sturdy, reliable air-damped compensator
- High-contrast image
- Inspection record
- Comes with plumb bob, adjusting pin and robust case
- Also available as a set

**Nedo Builders' Levels X-Series**

	X20	X24	X28	X32
<b>Ref.-No.</b> (horizontal circle gon)	460 770-613	460 745-613	460 787-613	460 792-613
<b>Ref.-No.</b> (horizontal circle degrees)	460 771-613	460 746-613	460 788-613	460 793-613
<b>Ref.-No. Set</b> (horizontal circle gon)	462 205	462 245	462 285	462 325
<b>Image</b>	upright	upright	upright	upright
<b>Magnification</b>	20x	24x	28x	32x
<b>Clear objective aperture</b>	30 mm	36 mm	36 mm	36 mm
<b>Shortest focusing distance</b>	0.6 m	0.6 m	0.6 m	0.6 m
<b>Multiplication factor</b>	100	100	100	100
<b>Compensator operating range</b>	± 15'	± 15'	± 15'	± 15'
<b>Setting accuracy</b>	± 0.5"	± 0.5"	± 0.4"	± 0.3"
<b>Horizontal circle</b>	400 gon / degrees	400 gon / degrees	400 gon / degrees	400 gon / degrees
<b>Sensitivity of circular bubble</b>	8'2 mm	8'2 mm	8'2 mm	8'2 mm
<b>Standard deviation per km double-run levelling</b>	± 2.5 mm	± 2.0 mm	± 1.5 mm	± 1.0 mm
<b>Protection class</b>	IP 54	IP 54	IP 54	IP 54
<b>Weight</b>	1.7 kg	1.7 kg	1.7 kg	1.7 kg
<b>Connecting thread</b>	5/8"	5/8"	5/8"	5/8"



## Nedo Engineers' Levels Z-Series

Nedo **Z-Series levels** are premium engineers' levels that meet the most exacting demands. The levels in this series have an especially large aperture to provide plenty of light-gathering power, a rugged, air-damped compensator and a jet-water proof metal housing conforming to protection class IP X6. Perfect for extreme conditions like dust and rain.



### Features:

- Automatic engineers' level with 24x, 28x or 32x magnification
- Bright optics with large objective aperture
- Rugged metal housing
- Jet water and dust proof; IP X6
- Large objective aperture: 36 mm
- Sturdy, reliable air-damped compensator
- High-contrast image
- Inspection record
- Comes with plumb bob, adjusting pin and robust case
- Also available as a set

### Nedo Engineers' Levels Z-Series

	Z24	Z28	Z32
<b>Ref.-No.</b> (horizontal circle gon)	460 756	460 757	460 758
<b>Ref.-No.</b> (horizontal circle degrees)	460 756-633	460 757-633	460 758-633
<b>Ref.-No. Set</b> (horizontal circle gon)	465 245	465 285	465 325
Image	upright	upright	upright
Magnification	24x	28x	32x
Clear objective aperture	36 mm	36 mm	36 mm
Shortest focusing distance	0.65 m	0.65 m	0.65 m
Multiplication factor	100	100	100
Compensator operating range	± 15'	± 15'	± 15'
Setting accuracy	± 0.5"	± 0.4"	± 0.3"
Horizontal circle	400 gon / degrees	400 gon / degrees	400 gon / degrees
Sensitivity of circular bubble	8'/2 mm	8'/2 mm	8'/2 mm
Standard deviation per km	± 2.0 mm	± 1.5 mm	± 1.0 mm
double-run levelling			
Protection class	IP X6	IP X6	IP X6
Weight	1.75 kg	1.75 kg	1.75 kg
Connecting thread	5/8"	5/8"	5/8"



#### Levelling set with Z-level consisting of:

- 5 m levelling staff and bag No. 345 122-613
- Aluminium tripod No. 200 215-613

**Batter board holder for theodolite**

Sturdy aluminium batter board holder with four clamping screws.  
Ref.-No. 461 051



**Diagonal eyepiece**

Designed for measuring steep vertical angles.  
With bag.  
Ref.-No. 460 813-613



## Nedo ET-5 Electronic Theodolite with Optical Plummet or Laser Plummet

Robust builders' theodolite with digital display and automatic vertical compensator. The Nedo ET-5 stands out thanks to its precision, reliability and simple and intuitive handling.

**Features:**

- Bright optics with 30x magnification
- 2 large, easy-to-read LCD illuminated displays
- 2 clearly arranged control panels
- Automatic vertical compensator; Working range  $\pm 3'$
- Horizontal circle with right/left function
- Horizontal circle can be set to zero in any position
- Hold function for horizontal circle
- Automatic switch-off after 30 minutes; can be deactivated
- Robust tribrach with 5/8" connecting thread
- Incl. batteries, rechargeable batteries, charger, plumb bob, weather protection, tools and robust case
- Available with optical plummet or with laser plummet



### Nedo Electronic Theodolite ET-5 with Optical Plummet or Laser Plummet

	ET-5 with optical plummet	ET-5 with laser plummet
Ref.-No.	460 812-613	460 814-613
Magnification	30x	30x
Shortest focusing distance	1.35 m	1.35 m
Clear objective aperture	45 mm	45 mm
Minimum reading	1" or 5"	1" or 5"
Accuracy	5"	5"
Angle units	degrees(0-360) / gon(0-400) / mil (0-6400)	Grad(0-360) / Gon(0-400) / mil (0-6400)
Spirit level	30"/2 mm	30"/2 mm
Circular bubble	8'/2 mm	8'/2 mm
Connecting thread of tribrach	5/8" BSW	5/8" BSW
Operating temperature	-20°C to +50°C	-20°C to +50°C
Power supply	4 x 1.5 V AA or rechargeable batteries	4 x 1.5 V AA or rechargeable batteries
Operation duration	batteries 36 h, rechargeable batteries 18 h	batteries 36 h, rechargeable batteries 18 h
Weight	4.7 kg	4.7 kg
Magnification optical plummet	3x	
Accuracy optical plummet	$\pm 0.5$ mm/1.5 m	
Accuracy laser plummet		$\pm 1.5$ mm/1.5 m
Laser plummet		<1 mW, laser class 2, 650 nm
Protection class	IP 54	IP 54





## TRIPODS



---

## Get the Maximum Accuracy out of your Surveying Instrument

The stability of a tripod has great impact on the precision achieved with a levelling instrument, a construction laser, a total station or a 3D laser scanner. Depending on the type of instrument, tripods have to meet different requirements and specifications.

Bearing this in mind, Nedo has developed a unique range of tripods comprising aluminium tripods, elevating tripods, wooden tripods and practical accessories. The latest addition are Industrial Line elevating tripods which are designed specifically for use with 3D laser scanners. No matter how different Nedo tripods may look like, they have one feature in common: Stability to get the maximum accuracy out of your surveying instrument.





## Standard or Elevating Tripod?

Nedo standard tripods without a crank mechanism are ideal for levelling tasks with builders' levels or horizontal lasers. Nedo elevating tripods are recommended for applications that require an exact adjustment of the construction laser to a certain working height, e.g. in ceiling construction and other installation work. The desired working height, even of heavy-duty rotating lasers, can be adjusted quickly with Nedo elevating tripods.



## Aluminium or Wood?

Modern construction tripods are made of aluminium. Nedo aluminium tripods are lightweight, extremely robust and rigid. They are suitable for the use with builders' levels, rotating lasers and builders' theodolites. Surveyors however, prefer wooden tripods for high-precision instruments as they feature a better damping behaviour and are less affected by temperature changes than aluminium tripods.

The wooden parts of all Nedo wooden tripods are coated with a high-tech plastic material to protect them against moisture. This ensures that Nedo wooden tripods are extremely weatherproof and robust.



## Details which matter

Nedo tripods set standards in terms of stability, reliability and extremely robust design. Furthermore, all Nedo tripods feature the following details which matter on the job:

- **Aluminium quick release levers: perfect for the use under tough conditions on the construction site**
- **Brass hinge pins: robust and reliable**
- **Retaining screw with plumb bob hook that folds away to the side: perfect for the use of an optical or a laser plummet**

Nedo tripods for use in interior finishing are equipped with a slip guard that prevents the tripod legs from slipping on slippery floors.





## Short and Lightweight Aluminium Tripods



**Tripod Ref.-No. 200 631**

- Min. effective height approx. 0.58 m
- Max. effective height approx. 0.85 m
- Retracted length approx. 0.62 m
- Holding screw: 5/8" thread
- Weight approx. 3.00 kg
- Tripod head flat, Ø 140 mm

**Features:**

- Quick clamp
- Slip guard

**Suitable for:**

- Dot and line lasers
- Rotating lasers



**Tripod Ref.-No. 200 412**

- Min. effective height approx. 0.78 m
- Max. effective height approx. 1.18 m
- Retracted length approx. 0.82 m
- Holding screw: 5/8" thread
- Weight approx. 4.00 kg
- Tripod head flat, Ø 140 mm

**Features:**

- Quick clamp
- Slip guard

**Suitable for:**

- Dot and line lasers
- Rotating lasers



**Tripod Ref.-No. 200 215-613**

- Min. effective height approx. 0.91 m
- Max. effective height approx. 1.49 m
- Retracted length approx. 0.97 m
- Holding screw: 5/8" thread
- Weight approx. 2.70 kg
- Tripod head flat, Ø 120 mm

**Features:**

- Quick clamp
- Carrying strap

**Suitable for:**

- Builders' levels
- Rotating lasers



**Tripod Ref.-No. 200 625**

- Min. effective height approx. 0.98 m
- Max. effective height approx. 1.68 m
- Retracted length approx. 1.05 m
- Holding screw: 5/8" thread
- Weight approx. 3.00 kg
- Tripod head flat, Ø 140 mm

**Features:**

- Tripod head made of impact-resistant plastic
- Circular bubble in tripod head
- Quick clamp
- Slip guard

**Suitable for:**

- Builders' levels
- Rotating lasers



**Tripod Ref.-No. 200 621  
Tripod Ref.-No. 200 621-614**

- Min. effective height approx. 1.00 m
- Max. effective height approx. 1.65 m
- Retracted length approx. 1.07 m
- Holding screw: 5/8" thread
- Weight approx. 3.80 kg
- Tripod head flat, Ø 140 mm

**Features:**

- Quick clamp
- Slip guard  
(tripod Ref.-No. 200 621-614)

**Suitable for:**

- Builders' levels
- Rotating lasers



**Tripod Ref.-No. 200 622**

- Min. effective height approx. 1.02 m
- Max. effective height approx. 1.67 m
- Retracted length approx. 1.09 m
- Holding screw: 5/8" thread
- Weight approx. 4.20 kg
- Tripod head domed, Ø 140 mm

**Features:**

- Quick clamp
- Domed head

**Suitable for:**

- Builders' levels
- Rotating lasers

# Medium-Duty Aluminium Tripods



**Tripod Ref.-No. 200 225**

- Min. effective height approx. 0.99 m
- Max. effective height approx. 1.68 m
- Retracted length approx. 1.06 m
- Holding screw: 5/8" thread
- Weight approx. 3.8 kg
- Tripod head flat, Ø 140 mm

**Features:**

- Quick clamp
- Carrying strap
- Slip guard
- Leg locking system without a strap

**Suitable for:**

- Builders' levels
- Rotating lasers
- Theodolites



**Tripod Ref.-No. 200 250**

- Min. effective height approx. 1.01 m
- Max. effective height approx. 1.63 m
- Retracted length approx. 1.08 m
- Holding screw: 5/8" thread
- Weight approx. 4.6 kg
- Tripod head flat, Ø 154 mm

**Features:**

- Quick clamp
- Carrying strap

**Suitable for:**

- Builders' levels
- Rotating lasers
- Theodolites



**Tripod Ref.-No. 200 200**

- Min. effective height approx. 1.08 m
- Max. effective height approx. 1.72 m
- Retracted length approx. 1.14 m
- Holding screw: 5/8" thread
- Weight approx. 5.00 kg
- Tripod head flat, Ø 140 mm

**Features:**

- Quick clamp
- In accordance with ISO 12858-2-LF

**Suitable for:**

- Builders' levels
- Rotating lasers
- Theodolites





## Medium- and Heavy-Duty Aluminium Tripods



**Tripod Ref.-No. 200 233**

- Min. effective height approx. 1.08 m
- Max. effective height approx. 1.72 m
- Retracted length approx. 1.14 m
- Weight approx. 5.00 kg
- Holding screw: 5/8" thread
- Tripod head flat, Ø 140 mm

**Features:**

- Wing nut clamp

**Suitable for:**

- Builders' levels
- Rotating lasers
- Theodolites



**Tripod Ref.-No. 200 312**

- Min. effective height approx. 1.10 m
- Max. effective height approx. 1.74 m
- Retracted length approx. 1.16 m
- Holding screw: 5/8" thread
- Weight approx. 5.40 kg
- Tripod head domed, Ø 140 mm

**Features:**

- Quick clamp
- Domed head
- In accordance with ISO 12858-2-LS

**Suitable for:**

- Builders' levels
- Rotating lasers



**Tripod Ref.-No. 200 524  
(heavy-duty type)**

- Min. effective height approx. 1.06 m
- Max. effective height approx. 1.70 m
- Retracted length approx. 1.13 m
- Holding screw: 5/8" thread
- Weight approx. 6.40 kg
- Tripod head flat, Ø 167 mm

**Features:**

- Large, round tripod head
- Quick clamp
- Snap Cap
- Carrying strap
- In accordance with ISO 12858-2-H

**Suitable for:**

- Builders' levels
- Theodolites
- Total stations
- Rotating lasers

# Lightweight Telescopic and Elevating Tripods



**Tripod Ref.-No. 210 620-613**

**Tripod Ref.-No. 210 619-613**  
(without image)

- Min. effective height approx. 0.53 m
- Max. effective height approx. 1.50 m
- Retracted length approx. 0.60 m
- Holding screw Tripod Ref.-No. 210 620-613: 5/8" thread
- Holding screw Tripod Ref.-No. 210 619-613: Interchangeable tripod head with 1/4" and 5/8" thread
- Weight approx. 1.85 kg
- Adjustable column range 300 mm

## Features:

- Quick clamp
- Slip guard
- Circular bubble in tripod head
- Carrying bag
- Tripod Ref.-No. 210 619-613: Interchangeable tripod head with 1/4" and 5/8" thread

## Suitable for:

- Dot and line lasers
- Lightweight rotating lasers



**Tripod Ref.-No. 210 215-613**

- Min. effective height approx. 0.82 m
- Max. effective height approx. 1.65 m
- Retracted length approx. 0.88 m
- Holding screw: 5/8" thread
- Weight approx. 3.58 kg
- Adjustable column range 400 mm

## Features:

- Quick clamp
- Aluminium tripod plate
- Carrying strap

## Suitable for:

- Dot and line lasers
- Lightweight rotating lasers



**Tripod Ref.-No. 210 631**

- Min. effective height approx. 0.69 m
- Max. effective height approx. 1.45 m
- Retracted length approx. 0.75 m
- Holding screw: 5/8" thread
- Weight approx. 3.50 kg
- Tripod plate, Ø 110 mm
- Adjustable column range 485 mm

## Features:

- Quick clamp
- Slip guard
- Circular bubble in tripod head
- Aluminium tripod plate

## Suitable for:

- Dot and line lasers
- Lightweight rotating lasers

The crank of elevating tripods with indirect gear moves the height-adjustable column via a reduction gear unit. This allows the desired height to be set precisely even with heavy-duty lasers. Furthermore, the reduction gear unit prevents any unintentional descent of the laser when the locking screw is opened. The indirect gear is a particularly convenient solution, especially when using heavy-duty rotating lasers.



## Medium-Duty Elevating Tripods



### Tripod Ref.-No. 210 618

- Min. effective height approx. 0.60 m
- Max. effective height approx. 1.51 m
- Retracted length approx. 0.80 m
- Holding screw: 5/8" thread
- Weight approx. 4.50 kg
- Tripod plate, Ø 110 mm
- Telescopic section 1-fold
- Adjustable column range 420 mm

#### Features:

- Indirect gear
- Slip guard
- Circular bubble
- Aluminium tripod plate
- mm graduation on telescopic tube

#### Suitable for:

- Rotating lasers



### Tripod Ref.-No. 210 613

- Min. effective height approx. 0.75 m
- Max. effective height approx. 1.60 m
- Retracted length approx. 0.81 m
- Holding screw: 5/8" thread
- Weight approx. 4.60 kg
- Tripod plate, Ø 110 mm
- Telescopic section 1-fold
- Adjustable column range 530 mm

#### Features:

- Direct gear
- Slip guard
- Circular bubble
- Aluminium tripod plate
- mm graduation on telescopic tube

#### Suitable for:

- Rotating lasers



### Tripod Ref.-No. 210 614

- Min. effective height approx. 0.74 m
- Max. effective height approx. 1.73 m
- Retracted length approx. 0.88 m
- Holding screw: 5/8" thread
- Weight approx. 5.20 kg
- Tripod plate, Ø 110 mm
- Telescopic section 1-fold
- Adjustable column range 555 mm

#### Features:

- Indirect gear
- Slip guard
- Circular bubble
- Aluminium tripod plate
- mm graduation on telescopic tube

#### Suitable for:

- Rotating lasers

Nedo elevating tripods are extremely robust and can withstand extremely adverse working conditions on a construction site. Highly stressed components such as the tripod plate, head with elevating gear, crank and of course the quick-clamping levers are made of strong aluminium.



## Medium-Duty Elevating Tripods



### Tripod Ref.-No. 210 616

- Min. effective height approx. 0.78 m
- Max. effective height approx. 2.03 m
- Retracted length approx. 1.02 m
- Holding screw: 5/8" thread
- Weight approx. 5.10 kg
- Tripod plate, Ø 110 mm
- Telescopic section 1-fold
- Adjustable column range 555 mm

#### Features:

- Indirect gear
- Slip guard
- Circular bubble
- Aluminium tripod plate
- mm graduation on telescopic tube
- Leg locking system without a strap

#### Suitable for:

- Rotating lasers



### Tripod Ref.-No. 210 612

- Min. effective height approx. 1.11 m
- Max. effective height approx. 2.36 m
- Retracted length approx. 1.20 m
- Weight approx. 5.70 kg
- Tripod plate, Ø 110 mm
- Telescopic section 1-fold
- Adjustable column range 612 mm

#### Features:

- Direct gear
- Slip guard
- Circular bubble
- Aluminium tripod plate
- mm graduation on telescopic tube

#### Suitable for:

- Rotating lasers



### Tripod Ref.-No. 210 621

- Min. effective height approx. 0.80 m
- Max. effective height approx. 2.76 m
- Retracted length approx. 1.06 m
- Weight approx. 5.32 kg
- Tripod plate, Ø 110 mm
- Telescopic section 2-fold
- Adjustable column range 582/642 mm

#### Features:

- Direct gear
- Quick clamp
- Slip guard
- Circular bubble
- Aluminium tripod plate
- mm graduation on telescopic tube
- Double telescope

#### Suitable for:

- Rotating lasers



The heavy-duty elevating tripods are equipped with combi tripod feet as a standard or can be upgraded later.

For work on uneven outdoor terrain activate the steel points by screwing in the rubber balls (fig. A). Hide the steel points with the rubber balls when working on smooth or sensitive floors (fig. B).

Also available as a set for later upgrading.

Ref.-No. 660 121

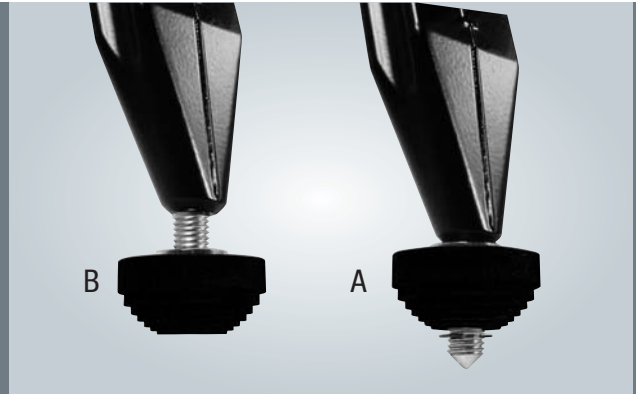

## Medium-Duty Elevating Tripods



**Tripod Ref.-No. 210 676**

- Min. effective height approx. 1.20 m
- Max. effective height approx. 2.38 m
- Retracted length approx. 1.28 m
- Weight approx. 7.00 kg
- Tripod plate, Ø 110 mm
- Telescopic section 1-fold
- Adjustable column range 555 mm

**Features:**

- Indirect gear
- Quick clamp
- Circular bubble
- mm graduation on telescopic tube
- Accessory: Combi tripod feet

**Suitable for:**

- Rotating lasers
- Heavy-duty rotating lasers



**Tripod Ref.-No. 210 675**

- Min. effective height approx. 0.80 m
- Max. effective height approx. 2.40 m
- Retracted length approx. 1.04 m
- Weight approx. 7.70 kg
- Tripod plate, Ø 110 mm
- Telescopic section 2-fold
- Adjustable column range 490/520 mm

**Features:**

- Indirect gear
- Reinforced telescopes
- Double telescope
- Circular bubble
- mm graduation on telescopic tube
- Accessory: Combi tripod feet

**Suitable for:**

- Rotating lasers
- Heavy-duty rotating lasers



**Tripod Ref.-No. 210 670**

- Min. effective height approx. 0.87 m
- Max. effective height approx. 2.85 m
- Retracted length approx. 1.12 m
- Weight approx. 7.00 kg
- Tripod plate, Ø 110 mm
- Telescopic section 2-fold
- Adjustable column range 595/695 mm

**Features:**

- Double telescope
- Direct gear
- Slip guard
- Circular bubble
- Combi tripod feet
- Aluminium tripod plate
- mm graduation on telescopic tube

**Suitable for:**

- Rotating lasers

Additional leg struts give the elevating tripods extra strength, making them suitable for use with heavy-duty lasers or for work at great heights, such as in ceiling construction. In addition, leg struts permit the use of tripods with castors, Ref.-No. 660110. In this way tripods and instruments can be quickly and easily moved to the place of deployment.



## Heavy-Duty Elevating Tripods with Additional Leg Struts



**Tripod Ref.-No. 210 660**

- Min. effective height approx. 0.55 m
- Max. effective height approx. 2.48 m
- Retracted length approx. 1.26 m
- Holding screw: 5/8" thread
- Weight approx. 7.20 kg
- Tripod plate, Ø 110 mm
- Telescopic section 2-fold
- Adjustable column range 310/395 mm

**Features:**

- Direct gear
- Double telescope
- Additional leg struts
- Quick clamp
- Aluminium tripod plate
- Circular bubble
- mm graduation on telescopic tube
- Accessory: Combi tripod feet

**Suitable for:**

- Heavy-duty rotating lasers



**Tripod Ref.-No. 210 680**

- Min. effective height approx. 0.85 m
- Max. effective height approx. 3.02 m
- Retracted length approx. 1.32 m
- Holding screw: 5/8" thread
- Weight approx. 8.75 kg
- Tripod plate, Ø 110 mm
- Telescopic section 2-fold
- Adjustable column range 600/590 mm

**Features:**

- Indirect gear
- Reinforced telescopes
- Additional leg struts
- Quick clamp
- Circular bubble
- Combi tripod feet
- mm graduation on telescopic tube

**Suitable for:**

- Heavy-duty rotating lasers



**Tripod Ref.-No. 210 442**

- Min. effective height approx. 1.77 m
- Max. effective height approx. 4.00 m
- Retracted length approx. 1.87 m
- Holding screw: 5/8" thread
- Weight approx. 11.20 kg
- Tripod plate, Ø 110 mm
- Telescopic section 2-fold
- Adjustable column range 600/590 mm

**Features:**

- Indirect gear
- Reinforced telescopes
- Additional leg struts
- Dual clamp
- Circular bubble
- mm graduation on telescopic tube
- Accessory: Combi tripod feet

**Suitable for:**

- Rotating lasers
- Heavy-duty rotating lasers



## Tripods for Machine Control Applications

The sturdy design of the Jumbo tripod allows vibration-free use of the machine control laser, even in windy conditions. The large working height ensures that the laser beam does not lie in the shadow of construction vehicles or other obstacles. The indirect gear unit can easily move lasers to the required working height, even if they are heavy.

The Nedo Jumbo Tripod: the elevating tripod for heavy-duty machine control lasers.



### Tripod Ref.-No. 210 530

- Min. effective height approx. 1.18 m
- Max. effective height approx 3.10 m
- Retracted length approx. 1.51 m
- Holding screw: 5/8" thread
- Weight approx. 14.6 kg
- Tripod plate, Ø 167 mm
- Adjust. column range 908 mm

### Features:

- Indirect gear
- Reinforced telescopes
- Additional leg struts
- Twist proof elevating column with centric clamp
- Circular bubble
- Quick clamp
- Slip guard
- mm graduation on telescopic tube
- Extra large tripod plate made of aluminium

### Tripod Ref.-No. 210 540

- Min. effective height approx. 1.73 m
- Max. effective height approx. 4.01 m
- Retracted length approx. 1.94 m
- Holding screw: 5/8" thread
- Weight approx. 17.2 kg
- Tripod plate, Ø 167 mm
- Adjust. column range 908 mm

### Features:

- Indirect gear
- Reinforced telescopes
- Additional leg struts
- Twist proof elevating column with centric clamp
- Circular bubble
- Quick clamp
- Slip guard
- mm graduation on telescopic tube
- Extra large tripod plate made of aluminium



### Set of Rubber Joints

Set consisting of 3 rubber joints. The rubber-covered underside ensures stability and prevents damage to sensitive floors.

Ref.-No. 660 010



*industrial line* 

## Elevating Tripods for Laser Scanners

Unlike rotating lasers which are set up once a day and which remain unchanged in that position all day long, laser scanners require elevating tripods that allow to easily lift and lower heavy-duty laser scanners continuously. When working with laser scanners, elevating tripods have to cope with a higher load applied which results in more wear and tear especially in the gear unit. Industrial Line is a new series of tripods perfectly adjusted to meet the special requirements of laser scanners or heavy-duty instruments.

### Features:

- Indirect gear to easily lift and lower heavy instruments
- Reinforced gear unit for extra durability and less wear and tear
- Twist proof elevating column with centric clamp
- Tripod legs made of strong aluminium profiles and leg struts for extra stability
- Combi shoes for all terrain use



## Industrial Line Elevating Tripod Ref.-No. 210 700

Universal elevating tripod for laser scanners.

The laser scanner can be mounted either at the top or bottom of the elevating column.

### Tripod Ref.-No. 210 700

- Min. effective height approx. 1.05 m
- Max. effective height approx. 2.57 m
- Retracted length approx. 1.28 m
- Holding screw: 5/8" thread
- Weight approx. 9.2 kg
- Tripod plate flat, Ø 110 mm
- Adjustable column range 818 mm
- mm graduation on telescopic tube





Circular level for simple alignment, even with an extended tripod

Inclusive transport case for 4 rack elements and accessories

## Industrial Line Shaft Tripod Ref.-No. 210 710

The new **Industrial Line shaft tripod** was designed especially for the use of 3D laser scanners in shaft applications. In these applications, the 3D laser scanner is inserted from above through a shaft cover into the shaft compartment. A particular highlight of the new Nedo **shaft tripod** is its toothed column, which extends to almost any length. Additional rack elements are inserted into the elevating head and securely connected to the previously inserted toothed column element with the aid of an innovative locking device.

### Tripod Ref.-No. 210 710

- Min. effective height approx. 1.12 m
- Max. effective height approx. 5.00 m
- Depth of shaft approx. 4.00 m
- Retracted length approx. 1.22 m
- Holding screw: 5/8" thread
- Weight approx. 8.9 kg
- Tripod plate flat, Ø 110 mm
- mm graduation on telescopic tube

### Scope of delivery:

- Elevating tripod with toothed column
- 4 rack elements, 1 m each, in a carrying bag
- 5 mm Allen key
- Magnetic bit holder for cordless screwdriver
- Hand crank with magnetic bit holder





## Accessories for Industrial Line Tripods

### Adapters for Laser Scanners

Depending on the weight, overhead mounting of a 3D laser scanner on a shaft tripod with a 5/8" socket may be difficult. To make this easier, adapters can be supplied as optional accessories for various laser scanners. They permit safe and easy attachment to the tripod.



### Nedo Adapters for Laser Scanners

Ref.-No.	
660 040	Adapter for Faro Focus 3D
660 041	Adapter for Leica HDS6200
660 042	Adapter for Leica Scanstation P20

### Tripod Dolly



Sturdy tripod dolly with large steerable and lockable wheels. The points of the tripod are placed in the recesses provided, and the feet are secured with a flexible strap. Easy, safe and convenient.

The tripod dolly has only two shanks, allowing it to be maneuvered through narrow doors and providing easy access to a laser scanner. The dolly can be folded up to save space in transport.

**Ref.-No. 660 030**

### Extension Column

Extra extension column, 1 m.

**Ref.-No. 660 020**



### Cordless Screwdriver

Cordless screwdriver for electric height adjustment.

**Ref.-No. 660 015**

Nedo wooden tripods are made of carefully selected ash wood. All wooden parts are sealed with a high-tech plastic material that keeps moisture out. This ensures that there is no swelling, shrinking or splintering of wood and it makes Nedo wooden tripods extremely robust and weatherproof. Nedo wooden tripods are more durable than tripods with regular lacquering.

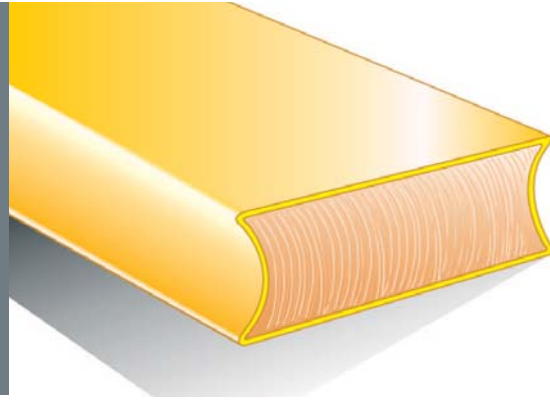

## Medium-Duty Wooden Tripods



### Tripod Ref.-No. 200 100

- Min. effective height approx. 1.02 m
- Max. effective height approx. 1.65 m
- Retracted length approx. 1.09 m
- Holding screw: 5/8" thread
- Weight approx. 5.40 kg
- Tripod head flat, Ø 140 mm

#### Features:

- Quick clamp
- Plastic-coated tripod legs
- In accordance with ISO 12858-2-LF

#### Suitable for:

- Digital levels
- Builders' levels
- Theodolites
- Total stations



### Tripod Ref.-No. 200 122

- Min. effective height approx. 1.05 m
- Max. effective height approx. 1.68 m
- Retracted length approx. 1.11 m
- Holding screw: 5/8" thread
- Weight approx. 5.50 kg
- Tripod head domed, Ø 140 mm

#### Features:

- Domed head
- Quick clamp
- Plastic-coated tripod legs
- In accordance with ISO 12858-2-LF

#### Suitable for:

- Digital levels
- Builders' levels
- Theodolites
- Total stations



### Tripod Ref.-No. 200 133

- Min. effective height approx. 1.02 m
- Max. effective height approx. 1.67 m
- Retracted length approx. 1.09 m
- Holding screw: 5/8" thread
- Weight approx. 5.10 kg
- Tripod head flat, Ø 140 mm

#### Features:

- Wing nut clamp
- Plastic-coated tripod legs
- Carrying strap
- In accordance with ISO 12858-2-LF

#### Suitable for:

- Digital levels
- Builders' levels
- Theodolites
- Total stations

### When precise measurements are critical.

Tripods are subjected to different stresses depending on how they are used. Robotic Total Stations, for example, generate large torsion forces through acceleration and braking that must be absorbed.

A study carried out by the Faculty of Geodesy at the University of Karlsruhe has shown that heavy wooden tripods made by Nedo can achieve the most accurate measurement results. The test series included heavy-duty wooden tripods and wood-fiberglass tripods from various manufacturers.

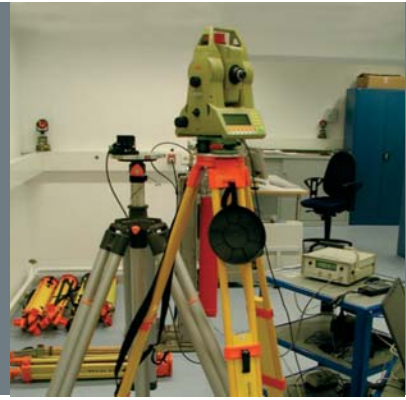

## Heavy-Duty Wooden Tripods



**Tripod Ref.-No. 200 513**

- Min. effective height approx. 1.02 m
- Max. effective height approx. 1.69 m
- Retracted length approx. 1.10 m
- Holding screw: 5/8" thread
- Weight approx. 7.60 kg
- Tripod plate flat, Ø 167 mm

### Features:

- Large, round tripod head
- Plastic-coated tripod legs
- Quick clamp
- Snap Cap
- Carrying strap
- In accordance with ISO 12858-2-H

### Suitable for:

- Total stations
- Digital levels
- Theodolites
- Heavy-duty rotating lasers



**Tripod Ref.-No. 200 533**

- Min. effective height approx. 1.05 m
- Max. effective height approx. 1.70 m
- Retracted length approx. 1.12 m
- Holding screw: 5/8" thread
- Weight approx. 7.10 kg
- Tripod plate flat, Ø 167 mm

### Features:

- Large, round tripod head
- Plastic-coated tripod legs
- Wing nut clamp
- Snap Cap
- Carrying strap
- In accordance with ISO 12858-2-H

### Suitable for:

- Total stations
- Digital levels
- Theodolites
- Heavy-duty rotating lasers



**Tripod Ref.-No. 200 532**

- Min. effective height approx. 1.05 m
- Max. effective height approx. 1.70 m
- Retracted length approx. 1.12 m
- Holding screw: 5/8" thread
- Weight approx. 7.10 kg
- Tripod plate flat, Ø 167 mm

### Features:

- Large, round tripod head
- Plastic-coated tripod legs
- Quick clamp
- Wing nut clamp
- Snap Cap
- Carrying strap
- In accordance with ISO 12858-2-H

### Suitable for:

- Total stations
- Digital levels
- Theodolites
- Heavy-duty rotating lasers



### Snap Cap

The Snap Cap tripod head cover is included with all Nedo heavy wooden tripods with a large round tripod head.



## Heavy-Duty Wooden Tripods



Simply press down the foot pedal and the transport locking device of the tripod legs opens automatically.

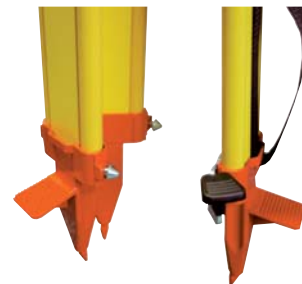

With just one "click", close the transport locking device again.

### Nedo Click Tripod

Bending down was yesterday! The bother of having to bend down each time to open and close the closing strap is now a thing of the past. Open the innovative click transport locking device simply by using the foot pedal. With just one click, close the locking device again for transport. Simple, reliable and convenient.

#### Tripod Ref.-No. 200 514

- Min. effective height approx. 1.02 m
- Max. effective height approx. 1.69 m
- Retracted length approx. 1.10 m
- Holding screw: 5/8" thread
- Weight approx. 7.75 kg
- Tripod plate flat, Ø 167 mm

#### Features:

- Click transport locking device
- Large, round tripod head
- Plastic-coated tripod legs
- Quick clamp
- Snap Cap
- Carrying strap
- In accordance with ISO 12858-2-H

#### Suitable for:

- Total stations
- Digital levels
- Theodolites
- Heavy-duty rotating lasers



#### Tripod Ref.-No. 200 511

- Min. effective height approx. 1.53 m
- Max. effective height approx. 1.61 m
- Holding screw: 5/8" thread
- Weight approx. 6.70 kg
- Tripod plate flat, Ø 167 mm

#### Features:

- Large, round tripod head
- Plastic-coated tripod legs
- Fixed tripod legs
- Snap Cap
- Carrying strap

#### Suitable for:

- Digital levels
- Theodolites
- Total stations

# Heavy-Duty Ceiling Monopod

Robust **ceiling monopod** for use with rotating lasers in confined spaces or stairways.

The segments are extremely stable and can be securely combined with a reliable locking mechanism. The crank mechanism allows to extend the **ceiling monopod** and to clamp the device between ceiling and floor. The tilting laser mount allows to adjust the working height of the laser, to mark slopes or to switch to the vertical mode of the laser easily.



## Features:

- Robust ceiling monopod for use in confined spaces
- Suitable for rooms as high as 3.08 m
- Robust crank drive to clamp the device between ceiling and floor
- Segments can be securely combined with reliable locking system
- Tilting laser mount to adjust the working height of the laser, to mark slopes and to switch to the vertical mode of the laser
- Ceiling monopod may be used as mounting support

## Tripod Ref.-No. 460 996:

- Min. effective height approx. 1.08 m
- Max. effective height approx. 3.08 m
- Weight approx. 5.10 kg
- Adjustable column range 510 mm

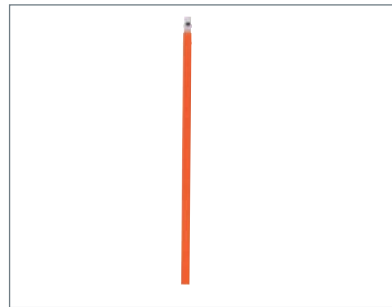

## 1 m Extension Segment Ref.-No. 460 998

Increases the working height of the ceiling monopod.

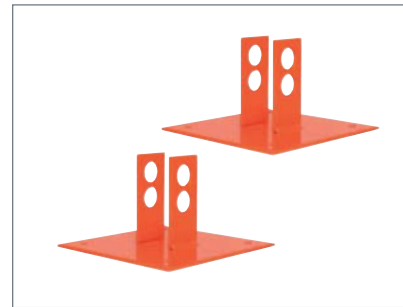

## Base Plates Ref.-No. 460 997

Base plates for setting up the ceiling monopod on a slanted or uneven surface.



In retrofitting, the Quick-Fix adapter plate is attached to the tripod with the clamping screw, and the round Quick-Fix adapter is attached to the instrument.



## Accessories for Tripods

### Nedo Quick-Fix

**Quick-Fix** is an innovative rapid locking system for attaching a level or laser to a tripod. The instrument can be fixed to the tripod without the need for a 5/8" clamping screw. No damage from falling, no wasted time. **Quick-Fix** fits any tripod with a 5/8" mounting thread.

**Ref.-No. 572 111**

#### Simple

With **Quick-Fix** the instrument can be securely fixed to the tripod and quickly taken off. You just move a lever.

#### Secure

Expensive damage from falling is prevented.

#### Fast

Place the instrument on the adapter plate, move the lever, done.



### Extra Large Tripod Head

Metal tripod head, extra large version, Ø 167 mm

#### Order information:

- **Ref.-No. 660 150** fits Nedo elevating tripods with a column diameter of 28 mm
- **Ref.-No. 660 160** fits Nedo elevating tripods with a column diameter of 36 mm
- **Ref.-No. 660 170** fits Nedo elevating tripods with a column diameter of 45 mm



### Tripod Adapter

Tripod adapter made of metal.

#### Order information:

- **Ref.-No. 059 220** Adapter for 5/8" thread to 1/4" thread
- **Ref.-No. 061 837** Adapter for 5/8" thread to 3/8" thread



**Nedo Laser Bail**  
Comfortable working near the floor



## Accessories for Tripods



### Laser Bail

---

Ideal when laying screed. The laser bail is fixed to the end of the crank column. The rotating laser can be operated near the floor and the height can be easily adjusted using the crank mechanism.

Laser bail fits any Nedo elevating tripod.

**Ref.-No. 660 131**



### Device Holder

---

The rotatable device holder accommodates field computer, data logger and controller etc. and is designed to fit all heavy-duty Nedo tripods featuring a large round tripod head.

**Ref.-No. 630 112**



### Tripod Bag

---

Length: 1300 mm

Ø: 220 mm

**Ref.-No. 655 112-613**



### Ballast Bag

---

Ballast bag for weighing down a tripod. The bag is attached to a tripod leg with two fixing straps.

Set consisting of 3 ballast bags and 6 fixing straps.

**Ref.-No. 660 011**



# Accessories for Tripods

## Combi Tripod Feet



For work on uneven outdoor terrain activate the steel points by screwing in the rubber balls (fig. A). Hide the steel points with the rubber balls when working on smooth or sensitive floors (fig. B).

**Ref.-No. 660 121**



## Tripod Castors Set

Accessory for heavy-duty elevating tripods with leg struts. Simply remove the tripod points and replace them with the tripod castors. Each castor is equipped with a brake. The set consists of three tripod castors.

Thread: M10

**Ref.-No. 660 110**



## Tripod Star

The Nedo tripod star is especially useful for securing tripods in indoor work on smooth floors.

**Ref.-No. 665 111**



## Elevating Head

To be mounted to any tripod with flat head. The tripod can then be used as an elevating tripod.

### Features:

- Connecting thread: 5/8"
- Adjustable range: 105 mm

**Ref.-No. 570 111**



**SURVEYING EQUIPMENT**

---

## More than 110 Years of Experience in the Manufacture of Surveying Accessories

The Nedo brand is inseparably linked with the surveying industry. For over 110 years we have worked on ways to improve the efficiency of geodetic measurements by developing innovative surveying accessories. Thanks to the precision and reliability of our products, the Nedo brand has become synonymous throughout the world for surveying accessories of superlative quality.

Nedo surveying accessories have an international reputation. Our Invar leveling staffs are used in almost every major construction project where maximum precision is required: in the 57-km Gotthard Base Tunnel, in new high-speed rail lines and in the tunnels of the CERN linear accelerator.

Thanks to our many years of experience we are thoroughly familiar with operating conditions and requirements for surveying accessories. We know what is important to users and what factors are critical in their day-to-day work. This knowledge is systematically applied when we develop and manufacture our products.





# Aluminium Telescopic Levelling Staffs with E-graduation

## Aluminium Telescopic Levelling Staffs

To meet differing quality demands Nedo offers two series of telescopic levelling staffs. Each series meets accuracy requirements in accordance with DIN 18703.



## QualiLine Telescopic Levelling Staffs

For maximum quality and accuracy. Nedo **QualiLine** telescopic levelling staffs are made of high-quality white powder-coated aluminium tubes. The rugged locking mechanism ensures that the telescopic sections lock securely into position. The levelling graduation on the front side is protected by standoff ribs. Nedo **QualiLine** telescopic levelling staffs are available with adjustable circular bubbles and graduation 1 and graduation 2 on the rear.

## StandardLine Telescopic Levelling Staffs

Reliable quality at an attractive price. Nedo **StandardLine** telescopic levelling staffs are made of anodised aluminium section tubes to withstand extreme demands on the construction site. A reliable locking mechanism with metal reinforced buttons ensures that the telescopic sections lock securely into position. **StandardLine** staffs are available with graduation 1 and 2 on the rear. The staffs are supplied with a carrying bag. Snap-on bubbles are available as accessories.

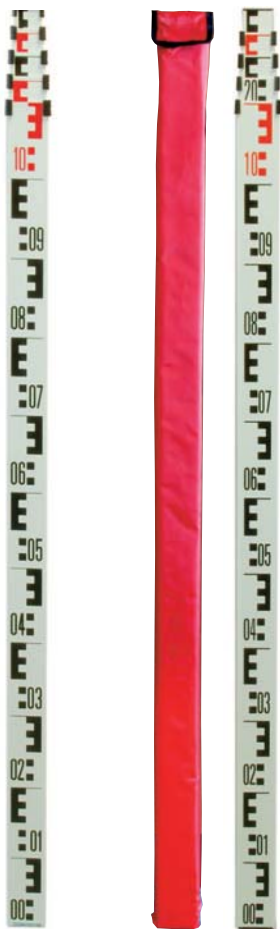

QualiLine  
Telescopic Levelling  
Staffs

StandardLine  
Telescopic Levelling  
Staffs  
incl. case



Graduation 1



Graduation 2

## Graduations on the Rear

### Graduation 1

Graduation for measurements of internal room heights.

### Graduation 2

Continuous mm-graduation, beginning with 0 at the staff's shoe.



Nedo QualiLine telescopic levelling  
staffs with adjustable circular bubble



### Nedo QualiLine Telescopic Levelling Staffs

Ref.-No.	Graduation on rear	Circular bubble	No. of sections	Length retracted	Measuring range	Weight
343 122-101	2	-	3	1.16 m	3.00 m	1.40 kg
344 115-101	1	-	4	1.19 m	4.00 m	1.80 kg
344 121	1	adjustable	4	1.19 m	4.00 m	1.80 kg
344 122	2	adjustable	4	1.19 m	4.00 m	1.80 kg
345 115-101	1	-	5	1.22 m	5.00 m	2.00 kg
345 121	1	adjustable	5	1.22 m	5.00 m	2.10 kg
345 122	2	adjustable	5	1.22 m	5.00 m	2.10 kg
345 122-101	2	-	5	1.22 m	5.00 m	2.00 kg

### Nedo StandardLine Telescopic Levelling Staffs

Ref.-No.	Graduation on rear	Circular bubble	No. of sections	Length retracted	Measuring range	Weight
344 115-613	1	-	4	1.22 m	4.00 m	1.50 kg
344 122-613	2	-	4	1.22 m	4.00 m	1.50 kg
345 115-613	1	-	5	1.22 m	5.00 m	1.80 kg
345 122-613	2	-	5	1.22 m	5.00 m	1.80 kg
347 122-613	2	-	5	1.69 m	7.00 m	2.30 kg

### Optional Accessories

Ref.-No.	
355 111-613	Bag, suitable for all telescopic levelling staffs
350 215	Snap-on bubble for QualiLine telescopic levelling staffs
350 216-613	Snap-on bubble for StandardLine telescopic levelling staffs 4 m
350 215-613	Snap-on bubble for StandardLine telescopic levelling staffs 5 m



# Special Levelling Staffs

## Fibreglass Levelling Staffs

Nedo **fibreglass levelling staffs** are especially sturdy and durable. The fibreglass sections are almost indestructible. The graduation on the front is protected by standoff ribs.

Nedo **fibreglass levelling staffs** are non-conducting when dry and are therefore especially suitable for levelling close to power lines or railways. Supplied with a bag as a standard.

### Nedo Fibreglass Levelling Staffs

Ref.-No.	Length retracted	Measuring range	Locking buttons	Snap-on bubble	Graduation on the rear	Weight
345 815	1.23 m	5.00 m	brass	yes	Graduation 1	2.7 kg
<b>New</b> 345 822	1.23 m	5.00 m	brass	yes	Graduation 2	2.7 kg
870 100	1.68 m	7.60 m	plastic	no	Graduation 1	3.2 kg



Inclusive case



## Nivellierfix

Thanks to the small diameter of its telescopic tubes, **Nivellierfix** is lightweight and compact. It is ideal for levelling and measuring interior dimensions.

The E-block scale on the front and the mm graduation on the back are equipped with an abrasion-proof anodised surface. The sturdy, locking mechanism never fails.

Available in lengths of 3 m, 4 m and 5 m.

A carrying bag is available as an accessory.

### Nedo Nivellierfix

Ref.-No.	Measuring range	Sections	Graduation	Weight
F 373 313	3.00 m	3	mm/E	0.8 kg
F 374 312	4.00 m	4	mm/E	1.0 kg
F 375 312	5.00 m	5	mm/E	1.1 kg

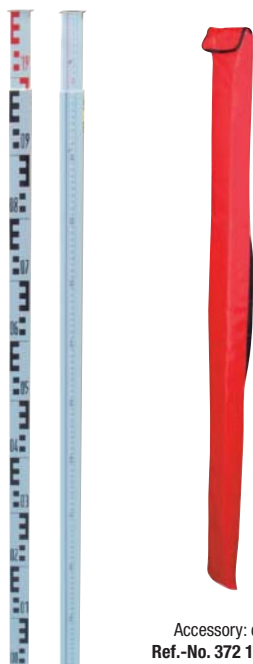

Accessory: case  
Ref.-No. 372 111-613



Adjustable circular bubble



## Folding Levelling Staffs

### Narrow Levelling Staffs, Wood

**Features:**

- Cross-section: 53 mm x 20 mm
- Wooden core of straight-fibered premium quality knot-free spruce or pine wood
- PVC coating encloses the wooden core like a box
- Double-coated narrow sides
- Galvanically zinced hinges and brackets

### Narrow Levelling Staffs, Aluminium

**Features:**

- Cross-section: 53 mm x 20 mm
- Very strong profile tubes with high stand-off ribs
- Profile tubes white powder-coated

### Wide Levelling Staffs, Wood

**Features:**

- Cross-section: 83 mm x 20 mm
- Wooden core of straight-fibered premium quality knot-free spruce or pine wood
- PVC coating encloses the wooden core like a box
- Double-coated narrow sides
- Galvanically zinced hinges and brackets

### Nedo Wooden Levelling Staffs, 53 mm wide

Ref.-No.	Length folded	Measuring range	Weight	Circular bubble
326 112	1.00 m	4.00 m	3.8 kg	-
326 112-615	1.00 m	4.00 m	3.8 kg	adjustable

### Nedo Aluminium Levelling Staffs, 53 mm wide

Ref.-No.	Length folded	Measuring range	Weight	Circular bubble
321 312	1.00 m	3.00 m	2.7 kg	-
321 312-615	1.00 m	3.00 m	2.7 kg	adjustable
326 312	1.00 m	4.00 m	3.8 kg	-
326 312-615	1.00 m	4.00 m	3.8 kg	adjustable

### Nedo Wooden Levelling Staffs, 83 mm wide

Ref.-No.	Length folded	Measuring range	Weight	Circular bubble
306 112	1.00 m	4.00 m	5.2 kg	-
306 112-615	1.00 m	4.00 m	5.2 kg	adjustable



The European research centre **CERN** operates the world's largest particle accelerator. Here elementary particles are accelerated to nearly the speed of light and then made to collide. Scientists use these experiments to explore conditions at the time of the Big Bang, when matter came into being.

The experiments are performed in a 27 km ring of superconducting magnets. These magnets as well as countless of sensors must be kept in perfect alignment. Exact horizontal positioning of these components over a distance of 27 km was a huge technical challenge. It was solved with Nedo precision Invar levelling staffs. The photo shows the inside of the tunnel. A Nedo precision Invar levelling staff has been placed at a reference point on the pipe.



## Nedo Precision Invar Levelling Staffs

Nedo **precision Invar levelling staffs** are used for first-order levelling and for challenging work on large scale construction sites, for example tunnels, roads, dams or power plants.

The graduation of the **precision Invar levelling staffs** is engraved in the paint coating with an interferometrically controlled laser beam, ensuring superior graduation accuracy and edge sharpness. Random graduation errors are less than  $\pm 0.015$  mm.

Nedo **precision Invar levelling staffs** outperform the requirements of DIN 18717 / ISO 12858-1 and set standards in terms of accuracy.



### Features:

- Body of Invar staff made of rigid aluminium profile with anodised surface
- Yellow lacquered graduation side; print protected by a 0.1 mm polyester coating
- Invar tape seated in protected groove of staff profile and tensioned by soft spring to compensate the extension coefficient of the staff profile. Extension coefficient:  $< 1.5 \times 10^{-6}$
- Foot plate slightly protrudes from staff body
- Foot plate of chrome-alloy, chemically nickel-plated steel; hardened and ground
- Equipped with circular bubble and fold-away handles as a standard. The handles are zinc and powder-coated.

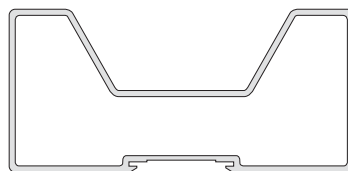

Staff profile

Available Invar staff graduations

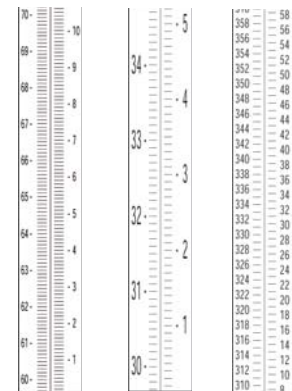

15a  
0.5 cm

17a  
1.0 cm

19a  
1.0 cm



Nedo precision Invar levelling staffs are used for first-order levelling, for example in the construction and monitoring of dams.



## Wide Staff Shoes



As an option, all Invar staffs can be equipped with wide staff shoes. The wide staff shoe allows staffs to be placed even on indented wall bolts.

**Existing precision Invar levelling staffs can only be retrofitted by Nedo.**

## Nedo Invar Levelling Staffs

Staff Shoes	Ref.-No. Graduation 15a	Ref.-No. Graduation 17a	Ref.-No Graduation 19a	Length	Weight
Standard staff shoes	391 185	391 187	391 189	1 m	3.0 kg
Wide staff shoes	391 185-616	391 187-616	391 189-616	1 m	3.0 kg
Standard staff shoes	392 185	392 187	392 189	2 m	4.3 kg
Wide staff shoes	392 185-616	392 187-616	392 189-616	2 m	4.3 kg
Standard staff shoes	393 185	393 187	393 189	3 m	5.5 kg
Wide staff shoes	393 185-616	393 187-616	393 189-616	3 m	5.5 kg

## Calibration Certificate

As an option, each Invar staff can be supplied with a calibration certificate, issued by the Technische Universität Munich.

**Ref.-No. 399 519** Length calibration without temperature cycle

**Ref.-No. 399 521** Length calibration with temperature cycle

The positions of the magnets and sensors in the CERN accelerator had to be measured with maximum precision under unfavourable lighting conditions. The LEDs on the staff gave uniform illumination to the bar-code without emitting thermal radiation. LED staff illumination is ideally suited for use with precision Invar levelling staffs. It permits precise measurements even with poor lighting.



## Precision Invar Levelling Staff Accessories

### Nedo LED Invar Staff Illumination

**LED Invar staff illumination** for Nedo high precision Invar staffs. The **Invar staff illumination** allows measurements to be taken with the Invar staff and a digital level in absolute darkness.

It can be used for example in mines, tunnels, night-time construction sites and for building monitoring. The measurement results are just as precise as measurements in daylight. Thanks to its compact design and integrated power supply, the mobility of the Invar staff is not reduced. Highly efficient LEDs in combination with specially designed optics and an optimized electronic unit ensure a long operating life. The lighting does not weaken during the battery running time, so dependable measurement is always possible. The system can be fitted to an Invar staff by the customer himself using standard tools, and requires no maintenance. The circular level of the Invar staff is additionally lit to permit precise measurements.

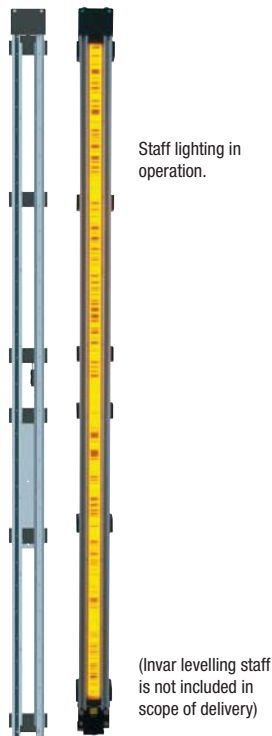

#### Features:

- Protection class IP 54
- Operating temperature -10°C to +50°C
- Level lighting
- Battery status display
- Detachable rechargeable battery with low self-discharge
- Battery life 5 to 10 hours depending on length

### Nedo LED Invar Staff Illumination

Ref.-No.	Length
396 115	suitable for 3 m Leica bar code Invar staff
396 116	suitable for 2 m Leica bar code Invar staff
396 117	suitable for 3 m Trimble bar code Invar staff
396 118	suitable for 2 m Trimble bar code Invar staff



### Base Plate (Frog)

The base plate is made of powdercoated grey cast iron.

#### Features:

- Spike
- Weight: 2.7 kg

Ref.-No. 333 121





# Precision Invar Levelling Staff Accessories



## Nedo Telescopic Struts

**Telescopic struts** are available as accessories for 2 m and 3 m precision Invar levelling staffs. The easy to handle telescopic struts ensure a secure stand of the precision Invar levelling staffs.

### Nedo Telescopic Struts

Ref.-No.	Length
399 211	2 m
399 311	3 m



## Nedo Transport Case for 2 Invar Staffs

Case for safe transport and storage of Nedo precision Invar levelling staffs. The **transport case** is made up of a sturdy aluminium frame and strong plastic honeycomb structured wall panels. The corners feature robust protectors. Handles allow for an easy handling. In addition, the case has a foam lining to protect the precision Invar levelling staffs. The transport case can accommodate two precision Invar levelling staffs, one precision Invar levelling staff with telescopic struts or one precision Invar levelling staff with illumination.

### Nedo Transport Case for 2 Invar Staffs

Ref.-No.	Length
395 111	for 1m staff length
395 121	for 2m staff length
395 131	for 3m staff length

### Nedo Case for 2 Invar Staffs with Wide Staff Shoes

Ref.-No.	Length
395 221	for 2m staff length
395 231	for 3m staff length



# Circular Bubbles, Staff Levels and Folding Levelling Rules



**Circular Bubble Ref.-No. 194 100**

- Adjustable
- Sensitivity: 12'



**Circular Bubble Ref.-No. 194 110**

- Adjustable
- Sensitivity: 25'



**Circular Bubble Ref.-No. 351 211**

- Removable
- Dovetail guide
- Sensitivity: 12'/2 mm



**Staff Level Ref.-No. 471 212**

- Metal staff level
- Adjustable
- Sensitivity: 25'



**Pocket Staff Level Ref.-No. 471 111**

- Wooden pocket staff level
- Longitudinal and face-end bubble
- Sensitivity: 15'



**Folding Levelling Rules Geomess**

- Sections of white painted wood, length: 0.3 m or 0.5 m
- Durable brass hinges
- Front: levelling graduation
- Back: mm-graduation

Ref.-No.	Length	Length of sections	Weight
698 911	2 m	0.5 m	0.35 kg
699 011	3 m	0.5 m	0.53 kg
699 311	3 m	0.3 m	0.68 kg
699 111	4 m	0.5 m	0.77 kg



# Self-Illuminating Levelling Staff LumiScale

**LumiScale** is a self-illuminating levelling staff for digital levels for use under unfavourable light conditions such as underground and tunnelling construction projects.

With regard to its precision, self-illuminating levelling staff **LumiScale** fulfills the norm DIN 18703.

The **LumiScale** graduation is back-lit via an electroluminescent foil which uniformly illuminates the entire graduation without any shades. Extensive tests, performed by the University of Graz, Austria, have proven that measuring errors are eliminated thanks to the equable illumination of the graduation. For this reason the **LumiScale** technology is superior to an external illumination of the graduation. **LumiScale** is available with bar codes for all common digital levels.

## Features:

- Illuminated graduation
- Illuminated bubble
- Supplied with rechargeable batteries, charger and bag

## Nedo LumiScale

Ref.-No.	
Ref.-No. 340 220	LumiScale with Trimble bar code
Ref.-No. 340 222	LumiScale with Leica DNA bar code
Ref.-No. 340 223	LumiScale with Topcon RAB bar code
Ref.-No. 340 224	LumiScale with Sokkia bar code
Ref.-No. 340 225	LumiScale with Leica-Sprinter bar code

Technical data:	
Graduation	bar code
Carrier of graduation	polyester film ( $\alpha_{TH} < 18 \text{ ppm}/^{\circ}\text{C}$ )
Accuracy	$\Delta l = \pm(0.2 \text{ mm} + 2l \cdot 10^{-4})$
Illuminated area	2125 mm x 25 mm
Illumination	electroluminescent foil
Power supply	removeable NiMH rechargeable batteries, 2000 mAh
Operation duration	approx. 5.5 h
Circular bubble	illuminated, sensitivity 12'
Protection class	IP 54
Dimensions	2200 mm x 70 mm x 60,5 mm
Body of staff	aluminium profile
Weight	approx. 4.0 kg (with rechargeable batteries)



**LumiScale control** – ideal for steady operation in structural monitoring, especially in unfavourable lighting conditions.

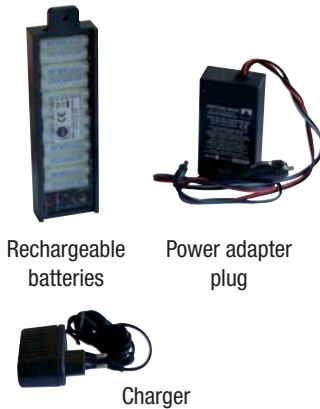

Rechargeable batteries

Power adapter plug

Charger

## Optional Accessories LumiScale

- Power adapter plug **Ref.-No. 030 816**
- Charger **Ref.-No. 030 794**
- Rechargeable batteries **Ref.-No. 061 866**

## LumiScale control

**LumiScale control** is a short, self-illuminating levelling staff for use in monitoring (for example in buildings). It is compact, with no bothersome attachments. **LumiScale control** can be plugged via a power supply unit into a 220 V outlet. It comes with a power supply unit and carrying bag.



### Nedo LumiScale control

Ref.-No.	
Ref.-No. 340 240	LumiScale control with Trimble bar code
Ref.-No. 340 242	LumiScale control with Leica DNA bar code
Ref.-No. 340 243	LumiScale control with Topcon RAB bar code
Ref.-No. 340 244	LumiScale control with Sokkia bar code

Technical data:	
Graduation	bar code
Carrier of graduation	polyester film ( $\alpha_{TH} < 18 \text{ ppm}/^{\circ}\text{C}$ )
Accuracy	$\Delta l = \pm(0.2^* \text{ mm} + 2l^*10^{-4})$
Illuminated area	430 mm x 23,5 mm
Illumination	electroluminescent foil
Power supply	power supply unit 12 VDC, 3 VA (m = 0.08 kg)
Length of connecting cable	approx. 2 m
Power requirement	approx. 120 mA
Protection class	IP 54
Dimensions	500 mm x 58 mm x 28 mm
Body of staff	aluminium profile
Weight	approx. 0.9 kg

# Overview EDM Accessories



**Ref.-No. 053 530**  
Leica adapter



**Ref.-No. 481 700-613**

- Suitable for Leica
- Push-button lock
- Offset: 34 mm
- Copper coated
- Prism Ø: 62 mm
- Accuracy:  $\pm 2''$



**Ref.-No. 484 704**  
Connection Leica pin  
Leica GPH 1



**Ref.-No. 481 300-613**

- Suitable for Sokkia, Topcon, Nikon, Pentax
- Metal yoke with 5/8" thread
- Offset: 0/30 mm
- Orange target
- Prism Ø: 62 mm
- Accuracy:  $\pm 2''$



**Ref.-No. 484 708**  
Connection  
5/8" pin for  
Zeiss KTR 1 N  
Omni #9125



**Ref.-No. 012 290**  
5/8" adapter



**Ref.-No. 481 200-613**

- Suitable for Sokkia, Pentax, Topcon, Nikon
- Plastic yoke with 5/8" thread
- Offset: 0/30 mm
- Prism Ø: 62 mm
- Accuracy:  $\pm 2''$



**Ref.-No. 484 709**  
Connection  
5/8" pin for  
Pentax MT 15  
Sokkia AP series

**Ref.-No. 481 601-613**



**Ref.-No. 481 601-613/  
Ref.-No. 481 600-613**

- Metal support/Metal housing
- Connecting thread: 5/8"
- Offset: 0/30 mm
- Circular bubble in support
- Double-sided target
- Prism Ø: 25.4 mm
- Accuracy:  $\pm 2''$
- Accessories



**Ref.-No. 484 707**  
Connection  
5/8" pin for  
Nedo mini-prism  
Omni JR. #1600

**Ref.-No. 481 600-613**

**Ref.-No. 687 111**  
Prism-mEssfix-S  
Length: 5.31 m



**Ref.-No. 484 651**  
Length: 2.15 m

**Ref.-No. 484 622**  
Length: 2.10 m

**Ref.-No. 484 600**  
Length: 2.20 m

**Ref.-No. 484 602**  
Length: 2.20 m

**Ref.-No. 484 650**  
Length: 2.15 m

**Ref.-No. 484 655**  
Length: 2.15 m

**Ref.-No. 484 621**  
Length: 2.10 m

**Ref.-No. 484 601**  
Length: 3.20 m



**Lightweight Prism Poles**



**Standard Prism Poles**



**Precision Prism Poles**



**Ref.-No. 482 015**  
Tribrach Adapter  
with optical plummet  
Colour: black



**Ref.-No. 482 011**  
Rotating Tribrach Adapter  
with 5/8" thread for prisms with  
5/8" female thread.  
Colour: black



**Ref.-No. 482 010**  
Fixed Tribrach Adapter  
with 5/8" thread for prisms with  
5/8" female thread.  
Colour: black



**Ref.-No. 482 020**  
Leica-Style reflector carrier,  
with Leica pin for push button lock.  
Colour: green



**Ref.-No. 481 100-613**  
Topcon-Style Prism Station,  
adjustable in height. Tribrach  
adapter with optical plummet  
Accuracy:  $\pm 2''$



**Ref.-No. 481 110-613**  
Leica-Style Prism Station,  
tribrach adapter with  
optical plummet.  
Accuracy:  $\pm 2''$



**Ref.-No. 481 120-613**  
Sokkia-Style Prism Station,  
tribrach adapter with  
optical plummet.  
Accuracy:  $\pm 2''$



**Ref.-No. 482 130**  
Tribrach without optical plummet,  
Universal 5/8" base plate with  
forced-centering locking.  
Colour: black



**Ref.-No. 482 100**  
Tribrach with optical plummet,  
universal 5/8" base plate with  
forced-centering locking and  
optical plummet.  
Colour: black



**Ref.-No. 483 535**  
Flexi-Grip



**Ref.-No. 483 521**  
Prism Pole Bipod



**Ref.-No. 200 533**  
Heavy-Duty Wooden Tripod



**Ref.-No. 200 513**  
Heavy-Duty Wooden Tripod





# Nedo Prism Poles

## Lite Prism Poles

Extremely lightweight **prism poles**.

Robust design and ergonomic soft grip for convenient handling. The poles can be taken apart for cleaning without any tools. Including replaceable points made of steel and carrying bag.

### Aluminium Prism Pole Ref.-No. 484 650

- 5/8" connection thread

### Aluminium Prism Pole Ref.-No. 484 651

- with Leica adapter

### Carbon Prism Pole Ref.-No. 484 655

- 5/8" connection thread

## Nedo Lightweight Prism Poles with Screw Clamp

Ref.-No.	Working range	Transport length	Weight	Accessory
484 650	125 cm - 215 cm	110 cm	0.74 kg	Incl. case
484 651	125 cm - 215 cm	119 cm	0.80 kg	Incl. case
484 655	125 cm - 210 cm	110 cm	0.50 kg	Incl. case

## Aluminium Prism Poles with Screw Clamp

Sturdy aluminium **prism poles** with screw clamp. Plastic handle with integrated adjustable circular bubble. The poles can be taken apart for cleaning without any tools. With replaceable steel points.

### Prism Pole Ref.-No. 484 621

- Standard model
- 5/8" connection thread

### Prism Pole Ref.-No. 484 622

- With combi adapter M8 / 5/8"
- Suitable for Zeiss TR1N prism

## Nedo Prism Poles with Screw Clamp

Ref.-No.	Working range	Transport length	Weight	Accessory: case
484 621	125 cm - 210 cm	110 cm	1.1 kg	494 112-613
484 622	125 cm - 210 cm	117 cm	1.1 kg	494 113-613





# Prism and GPS Poles

## Precision Aluminium Prism and GPS Poles

Excellent straightness even when fully extended



The top line of Nedo **prism poles** and **GPS poles** features an innovative clamping system that provides greater ease of use, maximum precision and excellent straightness, even when the pole is fully extended.

The **precision prism poles** have a maximum length of 2.20 m. They can also be supplied with a 1 m extension that can be parked in the scale tube for transport. This increases the maximum length to 3.20 m.

A **precision GPS pole** equipped with the same clamping system is also available with a length of 2.20 m. The scale tube can be additionally secured at 1.40 m, 1.60 m and 2.00 m using a permanently attached steel pin.

### Features:

- Excellent straightness even when fully extended
- Innovative clamping system
- Ergonomic soft grip for convenient handling
- Replaceable steel points
- Adjustable circular bubble with 20' accuracy
- 5/8" internal thread, compatible with all Nedo prism adapters

### Nedo Precision Prism and GPS Poles

Ref.-No.	Working range	Transport length	Weight	Accessory: Bag
484 600	129 cm - 220 cm	114 cm	1.18 kg	494 112-613
484 601	129 cm - 320 cm	114 cm	1.50 kg	494 112-613
484 602	129 cm - 220 cm	114 cm	1.18 kg	494 112-613

### Mini Prism Pin Pole Set



The set includes 3 sectional pin poles, each 600 mm long, with bag, steel point and 25 mm ø mini prism with bubble and bag.

### Features:

- Mini Prism: Ø 25 mm
- Offset: 0 mm
- Incl. accessories and carrying bag

Ref.-No. 484 643-613

# Nedo Prism-mEssfix-S and Accessories for Prism Poles



## Prism-mEssfix-S

Prism pole with analogue display. The built-in measuring tape displays the height of the centre of the prism in reference to the foot.

The extending sections are equipped with clamping screws, enabling each section to be locked in any position.

Working range: 1.53 m to 5.31 m.

The adapters for the most commonly used prisms are shown below.

**Important: When placing your order, please state the exact type of prism you will use with the Prism-mEssfix-S and the connecting thread of your prism.**

**Ref.-No. 687 111**



5/8" adapter  
012 290



Leica adapter  
053 530

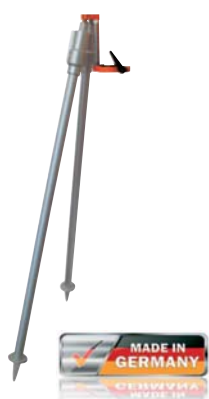

## Prism Pole Bipod

Solid prism pole bipod with 2 telescopic legs. Height adjustable by means of a push-button.

Suitable for all Nedo aluminium prism poles.

**Ref.-No. 483 521**

## Extension for Prism Pole

1 m extension, suitable for all Nedo prism poles.

5/8" connecting thread on both ends.

**Ref.-No. 383 615**



## Bag for Prisms

Suitable for all prisms.

**Ref.-No. 060 076**





## Prism Pole Accessories

### Nedo Prism Pole Support Flexi-Grip



Upgrade your tripod with 5/8" thread. Simply attach **Flexi-Grip** to a tripod. When releasing the central clamping screw the support clamp can be moved three-dimensionally in any direction.

The prism pole is positioned on the target point and aligned with the bubble. **Flexi-Grip** follows every movement in any direction. Once the upright position is found the entire system is fixed by using the central clamping screw. Very easy to handle.

With a tripod **Flexi-Grip** offers a secure stand and is therefore suitable for work in windy conditions.





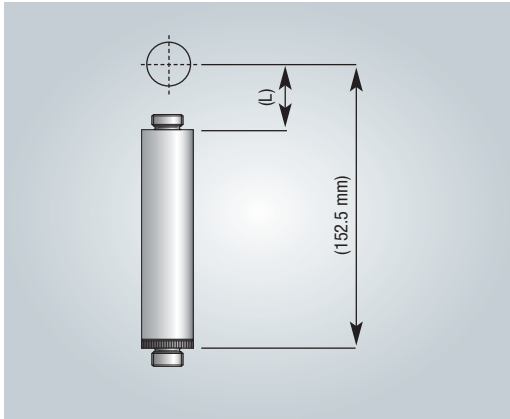













**Ref.-No. 483 535**





# Adapters to adjust the height of different prisms to the scale of all Nedo prism poles.



 <p><b>Ref.-No. 484 720</b> Connection 5/8" pin for Geodimeter System 500 Geodimeter System 600 L = 0 mm</p>	 <p><b>Ref.-No. 484 726</b> Connection 5/8" pin for Geodimeter Trimble System 5600 L = 0 mm</p>	 <p><b>Ref.-No. 484 731</b> Connection 5/8" pin for Trimble S6 L = 31.5 mm</p>	 <p><b>Ref.-No. 484 702</b> Connection M8 pin for Zeiss ETR 1 L = 33 mm</p>	 <p><b>Ref.-No. 484 695</b> Universal adapter Connection 5/8" pin L = 44 -136 mm</p>
 <p><b>Ref.-No. 484 728</b> Connection 1/4" pin for Leica flat-prism CPR 105 L = 50 mm</p>	 <p><b>Ref.-No. 484 718</b> Connection 5/8" pin for Geodimeter System 400 Geodimeter System 4000 L = 51 mm</p>	 <p><b>Ref.-No. 484 696</b> Universal adapter Connection 5/8" pin L = 65 -136 mm</p>	 <p><b>Ref.-No. 484 706</b> Connection 5/8" pin for Sokkia 025-0010 Sokkia 025-1110 L = 80 mm</p>	 <p><b>Ref.-No. 484 707</b> Connection 5/8" pin for Nedo mini-prism Ref.-No. 481 600 Omni JR. #1600 L = 70 mm</p>
 <p><b>Ref.-No. 484 717</b> Connection 5/8" pin for Topcon 5010 L = 78 mm</p>	 <p><b>Ref.-No. 484 704</b> Connection Leica pin for Leica GPH1 L = 85 mm</p>	 <p><b>Ref.-No. 484 713</b> Connection 5/8" pin for Zeiss TR 1 N L = 106 mm</p>	 <p><b>Ref.-No. 484 709</b> Connection 5/8" pin for Nedo prism Ref.-No. 481 200-613, Pentax MT 15 Sokkia AP series L = 97 mm</p>	 <p><b>Ref.-No. 484 708</b> Connection 5/8" pin for Nedo prism Ref.-No. 489 125, 481 300 Zeiss KTR 1 N Omni #9125 L = 100 mm</p>
 <p><b>Ref.-No. 484 721</b> Connection 5/8" pin for Geodimeter RMT L = 135 mm</p>	 <p><b>Ref.-No. 484 714</b> Connection 5/8" pin for Geodimeter L = 147.5 mm</p>	 <p><b>Ref.-No. 484 723</b> Connection M 10 female thread for Leica GDR 3 right angle prism</p>	 <p><b>Ref.-No. 484 715</b> Connection Leica pin for Leica GPH1A Omni #3425 L = 125 mm</p>	

Nedo Super Measuring Wheel, with railroad track guide. Perfect when measuring distances on railway tracks.



## Nedo Super Measuring Wheel

The Nedo **Super measuring wheel** meets the highest standards in terms of precision, quality and reliability.

Thanks to tight manufacturing tolerances and a high-quality counter, its accuracy is  $\pm 0.02\%$ , which corresponds to a maximum error of  **$\pm 2$  cm over a distance of 100 m**. The counter, which has a display resolution in cm, is mounted securely above the wheel and is driven by a toothed belt. Zero setting is done with a hand lever.

The brake is integrated into the sturdy rest support. The ergonomic pistol grip and the rugged aluminium guide bar make handling easy at all times. A clever mechanism permits the guide bar to be folded away for transport.



Transport case for Nedo Super measuring wheel.  
Ref.-No. 752 111

### Nedo Super Measuring Wheel

Ref.-No.	702 111
Wheel circumference	1 m
Measuring range	0 to 9,999.99 m
Counter arrangement	central
Resolution	0.01 m
Weight	approx. 3.65 kg
Tolerance	$\pm 0.02 \%$

## Nedo Railroad Track Guide

The **track guide** keeps the Nedo Super measuring wheel from slipping off the track, making it suitable for measurements on railway tracks.

It can be fitted easily without tools.

Ref.-No. 702 210





## Nedo Lightweight Measuring Wheels

The Nedo **lightweight measuring wheel** stands out thanks to its sturdy, ergonomic design. The abrasion-proof precision wheel and the precision counter ensure exact measurements. The pistol grip with an integrated brake button makes handling easy. A clever hinge mechanism permits the guide bar to be folded away, reducing the package dimensions to a minimum.



### Features:

- Robust and reliable
- Ergonomic design
- Precision wheel
- Precision counter with 0.1 m resolution
- Packed into a very small space

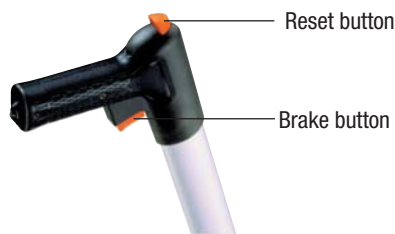

## Nedo Lightweight Measuring Wheel Professional

Ergonomically shaped pistol grip with brake and reset button.

## Nedo Lightweight Measuring Wheel Digital

The **lightweight measuring wheel Digital** is equipped with an easy-to-read digital display with resolution in centimeters. Various display formats m/cm, m/dm and m are optionally available. The device also features a hold function to retain the measured values and an automatic switch function.

### Features:

- Power supply: 2 x 1.5 V AA
- Operation duration: more than 350 h
- Protection class: IP 65
- Automatic switch-off after 3 minutes of non-use





The Nedo lightweight measuring wheel is protected against low pressure jet water and dust in line with IP 65. After use, the lightweight measuring wheel can even be sprayed down with water to clean it.



**Mini Measuring Wheel**  
Small and compact



**Lightweight Measuring Wheel Econo**  
Attractive price



**Lightweight Measuring Wheel Deluxe**  
Robust and reliable



**Lightweight Measuring Wheel Professional**  
Easy handling



**Lightweight Measuring Wheel Digital**  
Digital display with cm resolution

	Mini Measuring Wheel	Lightweight Measuring Wheel Econo	Lightweight Measuring Wheel Deluxe	Lightweight Measuring Wheel Professional	Lightweight Measuring Wheel Digital
<b>Ref.-No.</b>	703 113	703 116	703 111	703 112	703 118
<b>Ref.-No. Set</b> (with trekking rucksack)	703 125	703 126	703 115	703 120	703 128
Wheel circumference	0.5 m	1 m	1 m	1m	1m
Measuring range	0-9999.90 m	0-9999.90 m	0-9999.90 m	0-9999.90 m	0-9999.99 m
Resolution	0.1 m	0.1 m	0.1 m	0.1 m	0.01 m
Weight	1.2 kg	2.1 kg	2.3 kg	2.4 kg	1.85 kg
Tolerance	± 0.05%	± 0.05%	± 0.05%	± 0.05%	± 0.05%



All Nedo lightweight measuring wheels can be supplied as a set with a convenient trekking rucksack.



## One-Piece Ranging Poles

Nedo ranging poles are used in any situation involving surveying and marking. They are carefully made of high-quality materials. Permanent quality controls guarantee the well-known Nedo quality.

Points B and E are designed for the use on sandy grounds; points A and D are made for the use on clay soil.



### Nedo Wooden Ranging Poles

All wooden ranging poles are made of knot-free, well-seasoned spruce wood. The lacquer is applied in two layers by a dipping process. The lacquers used are weatherproof.

### Wooden Ranging Poles with Heavy-Duty Point

Wood quality and treatment same as for standard ranging poles, but with heavy-duty point.

### Nedo Fibreglass Ranging Poles

Nedo fibreglass ranging poles stand out thanks to their high strength and exceptional straightness. They are virtually unbreakable, springing back to their original form - even after extreme demand.

### Nedo Tubular Steel Ranging Poles

Nedo tubular steel ranging poles are made of highgrade steel and feature a high-density 0.5 mm PVC coating which protects them from corrosion. The tip is forged on.

### Nedo Construction Ranging Poles

Construction ranging poles are used especially for marking-out work on construction sites. Their diameter of 26 mm makes them extremely strong. The tip is forged on.

### Nedo Wooden Ranging Poles with Luminous Lacquering

Ref.-No.	No. of poles in package	Length incl. point	Pole Ø	Coating	Type of point
123 111	12	2.16 m	28 mm	Lacquer	A
123 112	12	2.16 m	28 mm	Lacquer	B
123 311	12	2.16 m	28 mm	Lacquer	D

### Nedo Wooden Ranging Poles with Heavy-Duty Point and Luminous Lacquering

Ref.-No.	No. of poles in package	Length incl. point	Pole Ø	Coating	Type of point
123 121	12	2.16 m	28 mm	Lacquer	A
123 122	12	2.16 m	28 mm	Lacquer	B
123 132	12	2.16 m	28 mm	Lacquer	E

### Nedo Fibreglass Ranging Poles

Ref.-No.	No. of poles in package	Length incl. point	Pole Ø	Coating	Type of point
112 421	12	2.16 m	25 mm	PVC	D
113 432	12	2.16 m	25 mm	PVC	E

### Nedo Tubular Steel Ranging Poles

Ref.-No.	No. of poles in package	Length incl. point	Pole Ø	Coating	Type of point
127 511	12	2.16 m	24 x 0.8 mm	PVC	D

### Nedo Ranging Poles

Ref.-No.	No. of poles in package	Length incl. point	Pole Ø	Coating	Type of point
122 515	16	2.00 m	26 x 0.6 mm	PVC	D

# Sectional Nedo Ranging Poles

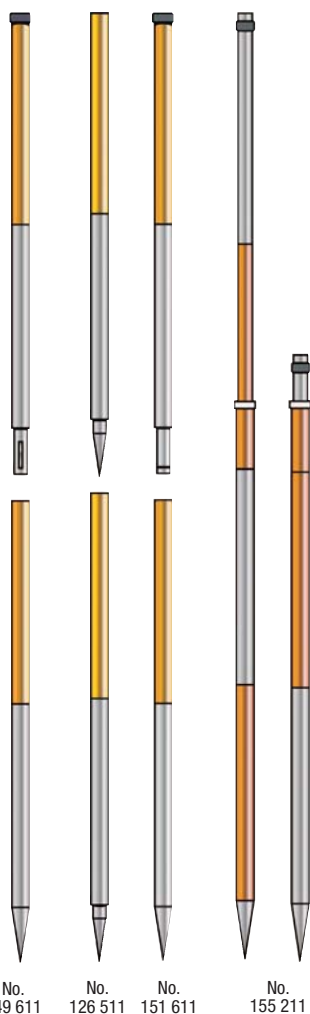

No. 149 611    No. 126 511    No. 151 611    No. 155 211

## Sectional Steel Ranging Pole

### Features:

- Continuously extensible due to lamella connectors
- Cross-section: 24 mm x 0.8 mm
- PVC coating: approx. 1 mm
- Luminous lacquering
- No. of poles in package: 12 pcs.

Ref.-No. 149 611



## Sectional Steel Ranging Pole

### Features:

- With a point on each metre element
- Cross-section: 24 mm x 0.8 mm
- PVC coating: approx. 1 mm
- Luminous lacquering
- No. of poles in package: 12 pcs.

Ref.-No. 126 511



## Sectional Aluminium Ranging Pole

### Features:

- Cross-section: 24 mm x 0.8 mm
- PVC coating: approx. 1 mm
- Bottom section reinforced with wood
- Quick clamp connects bottom and top section
- Luminous lacquering
- Solid, medium-duty point
- Point weight: 0.23 kg
- No. of poles in package: 12 pcs.
- Length 2.16 m

Ref.-No. 151 611 point A

Ref.-No. 151 612 point B



## Nedo Telescopic Ranging Poles

The telescopic ranging pole consists of two steel tubes, one sliding inside the other like a telescope. A quick clamp allows the sliding tube to be locked in any position. The telescopic pole can therefore also be used as plumb pole.

Ref.-No. 155 211 point A

Ref.-No. 155 212 point B



No. 156 111    No. 160 111

## Nedo Canvas Bags for Sectional Ranging Poles

Ref.-No.	Suitable for
156 111	6 telescopic poles No. 155 211, 155 212 or 3 poles (6 sections) No. 126 511, 149 611 No. 151 611, 151 612
160 111	6 telescopic poles No. 126 511, 149 611 or No. 151 611, 151 612

# Nedo Ranging Pole Supports

Nedo ranging pole supports feature a robust design and high stability. Therefore, they can be used for ranging poles as well as for prism poles and GPS poles.



## Nedo Heavy-Duty Ranging Pole Support

### Features:

- Heavy-duty design
- Tripod legs with zinc-coated telescope mechanism
- Orange powder-coated metal parts
- Ball joint head with support clamp
- Height: 0.80 m – 1.40 m
- Weight: 3.2 kg

Ref.-No. 177 211



## Ranging Pole Support

### Features:

- Lightweight design
- Orange powder-coated legs
- Ball joint head with support clamp
- Tripod legs locked by thumb screw
- Height: 1 m
- Weight: 1.6 kg
- No. of poles in package: 5 pcs.

Ref.-No. 177 111 (No. of poles in package: 5 pcs.)

Ref.-No. 177 111-616 (No. of poles in package: 1 pcs.)



## Ranging Pole Support

### Features:

- Lightweight design
- Identical to Ref.-No. 177 111, but without possibility of locking the legs
- Height: 1 m
- Weight: 1.6 kg

Ref.-No. 176 111 (No. of poles in package: 5 pcs.)

Ref.-No. 176 111-616 (No. of poles in package: 1 pcs.)



# Surveying Accessories

## Field Umbrella



The ideal protection against rain and sun. Available in three different sizes. Supplied with three support ropes as a standard. Ground spike and carrying bag available as accessories.

### Nedo Field Umbrellas

Ref.-No.	Ø
307 111	1.5 m
309 111	1.8 m
311 111	2.0 m

### Accessories

Ref.-No.	
316 111	Ground spike
315 111	Carrying bag



Ground spike for field umbrellas



Carrying bag for field umbrellas



## Nedo Field Bag

The practical canvas bag stores your measuring tape, calculator, field frame, optical square etc. Equipped with practical handle and shoulder strap. Additional pockets on the front for pens etc. Ref.-No. 655 111

## Nedo Field Frames

For notes and drawing on construction sites Nedo's field frame is indispensable. A robust aluminium plate serves as a writing pad. A thick transparent foil protects the drawings. Two metal lock knobs. Frame made of wood or plastics. Available in A4 or A3 size.

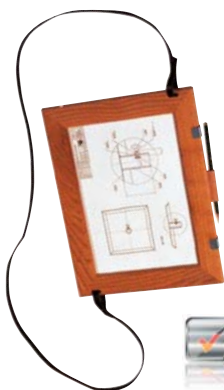

### Nedo Field Frames

Ref.-No.	Version	Size	Weight
645 250	Wood	DIN A4	0.7 kg
645 242	Plastic	DIN A4	0.8 kg
645 245	Wood	DIN A3	1.1 kg
645 260	Plastic	DIN A3	1.4 kg

# Surveying Accessories



## Double Pentaprism with Wide Angle

Field of view:  $\pm 45^\circ$ . Mirrorcoated top and bottom surfaces of prisms. Extra large field of view and foresight viewing. With twist-off cap.

**Ref.-No. 761 111**

**Optional accessory:**  
Leather case Ref.-No. 763 111



## Double Pentaprism without Wide Angle

Same as large double Pentaprism Ref.-No. 761 111 but with smaller field of view.

**Ref.-No. 760 111**

**Optional accessory:**  
Leather case Ref.-No. 763 111



## Optical Square

90° prism, weight 25 g.

**Ref.-No. 762 111**

**Optional accessory:**  
Leather case Ref.-No. 764 111



## Leather Case

Suitable for double pentaprism (Ref.-No. 761 111 and Ref.-No. 760 111).

**Ref.-No. 763 111**



## Adapter

PVC adapter used to attach a double pentaprism to a ranging pole.

**Ref.-No. 154 111**

# Surveying Accessories



## Zinc Diecasting Plumb Bob

Polished steel. With removable brass head.

### Order information:

- Ref.-No. 780 150 Weight 150 g
- Ref.-No. 780 200 Weight 200 g
- Ref.-No. 780 250 Weight 250 g
- Ref.-No. 780 300 Weight 300 g
- Ref.-No. 780 350 Weight 350 g
- Ref.-No. 780 400 Weight 400 g
- Ref.-No. 780 500 Weight 500 g



## Steel Plumb Bob

With removable brass head.

### Order information:

- Ref.-No. 781 100 Weight 100 g
- Ref.-No. 781 150 Weight 150 g
- Ref.-No. 781 200 Weight 200 g



## Boning Rods

### Features:

- Wooden boning rods, painted red/white
- Packaging: 1 set of 3 boards is supplied in a carton
- Each set weight: 3.5 kg

Ref.-No.	
448 111	Tubular aluminium foot
448 112	Wooden foot



## Perlon plumb line

1 roll of perlon plumb line, 100 m

Ref.-No. 785 111



## High-Visibility Vest

High-visibility vest for better safety where visibility is poor.

Ref.-No. 620 001

## Nedo POS-System - Optimum Product Presentation

The new Nedo POS system will help you to present Nedo products more successfully at the point of sale.

Why? Because your customers will find a visually attractive product presentation where exciting Nedo products are displayed in a compact area and can be tried and tested right at the point of sale.

Our product information card system will help both the dealer and the end user to understand and use our products very quickly.

On top of that, our display system generates cross-selling effects, and this means more sales.

Why? Once the customer has stopped in front of the display and is interested in one product, you have a direct opportunity right there to arouse his interest in additional Nedo products.

Nedo offers you three different basic modules to present our best-selling items:

- All-purpose display panel (1m)
- Laser display panel (1m)
- Combination display panel (2m)

In addition, your Nedo sales consultant will be happy to help you put together your own display, tailored to your customers' needs and with the required products.

Generate more sales with the Nedo POS system!







Management Service

# CERTIFICATE

The Certification Body  
of TÜV SÜD Management Service GmbH

certifies that



**Nedo GmbH & Co. KG**  
Hochgerichtstr. 39 – 43  
D-72280 Dornstetten

has established and applies  
a Quality Management System for

**Development, manufacture and distribution of  
surveying equipment, measuring tools  
and laser products.**

An audit was performed, Report No. **70003157**  
Proof has been furnished that the requirements  
according to

**ISO 9001:2008**

are fulfilled. The certificate is valid until **2015-03-22**  
Certificate Registration No. **12 100 27821 TMS**



Munich, 2012-04-11

QMS-TGA-ZM-07-92

## Nedo Corporate Headquarters

---

### **Nedo GmbH & Co. KG**

Hochgerichtstrasse 39-43  
D-72280 Dornstetten  
Phone: +49/7443/2401-0  
Fax: +49/7443/2401-45  
Email: info@nedo.com

## International Sales Network

### **Austria**

---

#### **Uwe Meyer**

Phone: +49 172 7269319  
Fax: +49 7443 2401277  
Email: meyer@nedo.com

### **Belgium/Luxembourg**

---

#### **Prof Praxis NV/SA**

Scheibeekstraat 29  
BE-1540 Herne  
Phone: +32 2 3563752  
Fax: +32 2 3562178  
Email: sales@prof-praxis.com

### **Chile**

---

#### **Helga Rath y Cía. Ltda.**

Av. Luis Thayer Ojeda 610, Of. 102  
CL-Santiago de Chile  
Phone: +56 2 2328893  
Fax: +56 2 3358633  
Email: hrath@entelchile.net

### **Denmark**

---

#### **Tajima Trading ApS**

Kaervangen 7b  
DK-9560 Hadsund  
Phone: +45 9652 0860  
Fax: +45 9652 0861  
Email : hanne@tajima.dk

### **Netherlands**

---

#### **MEMO Import - Export b.v.**

Maaskade 20  
NL-5347 KD Oss  
Phone: +31 412 632 032  
Fax: +31 412 625 658  
Email: info@memo-oss.nl

### **South America**

---

#### **Agente COHIGE S.L.**

C/ Progreso, 95  
ZA-45593 Bargas (Toledo)  
Phone: +34 925 395 111  
Fax: +34 925 395 165  
Email: nedo-spain@nedo.com

### **Spain**

---

#### **Agente COHIGE S.L.**

C/ Progreso, 95  
ES-45593 Bargas (Toledo)  
Phone: +34 925 395 111  
Fax: +34 925 395 165  
Email: nedo-spain@nedo.com

### **Sweden**

---

#### **Alesto Agenturer**

Box 6264  
SE-10234 Stockholm  
Phone: +46 831 5400  
Fax: +46 589 50016  
Email: info@alesto.se

### **Switzerland**

---

#### **Fimex Messgerätebau AG**

Hauptstrasse 5  
CH-8259 Kaltenbach  
Phone: +41 52 7420020  
Fax: +41 52 7420029  
Email: info@fimexag.com

### **USA**

---

#### **Nedo**

2200 Ampere Drive  
P. O. Box 99556  
Louisville, KY 40269-0556  
Phone: 866-275-6336 (toll free)  
Fax: 502-266-5280  
Email: sales@usa.nedo.com

# Sales and Supply Conditions

1. The following Supply Conditions apply to all contracts, deliveries and other performances, including advisory services, unless they have been amended or excluded with our expressed consent.  
Any General Terms and Conditions of Business of the customer/purchaser are not binding even if we have not again expressly rejected them.
2. The prices applicable on the delivery date shall be determinant.
3. Deliveries valued at under 400 Euro net value of goods shall be shipped ex works. In the case of deliveries valued at over 400 Euro net value of goods, we will absorb the standard freight and postal charges.  
Deliveries abroad valued at 1,000 Euro or more net order value shall be shipped free German border.
4. Consignments are made exclusive of packing. The packing on pallets and in crates is made available at prime cost.
5. **Quotation and conclusion of contract**  
All our quotations are given without commitment. Contracts and other agreements shall become binding only by way of our written confirmation or delivery.  
If our sales staff or agents make oral agreements or provide assurances which go beyond the scope of our quotation, these shall always require our written confirmation in order to be valid. Unless otherwise agreed, documents forming part of the quotation, such as illustrations, drawings, particulars of weights and dimensions, are only approximate.
6. **Delivery conditions and defective performances**  
If specific lead-times or delivery dates are not fulfilled, the customer wishing to withdraw from the contract or claim compensation or nonfulfillment shall not be released from the need to allow a suitable grace period for the performance and to issue a statement that he will refuse the performance after the expiry of the period.  
This shall not apply if we have expressly stated in writing that a lead-time or delivery date is binding.  
Reasonable partial consignments are permissible.  
Lead-times – even those established after a delay – shall be suitably extended in the event of force majeure and also unforeseen impediments occurring after the conclusion of the contract and for which we are not responsible, in so far as such impediments seriously affected delivery of the purchased item.  
We shall not be held responsible for delay in delivering and failure (impossibility) to deliver as long as the person we employ fulfill our obligations and our own suppliers attribute no fault to us.  
We shall not be held liable for delayed deliveries or failures (impossibility) to deliver for which our suppliers are to blame. The customer's right to withdraw, after a grace period allowed to us has expired without result, remains unimpaired.
7. **Shipment and transfer of risk**  
Unless otherwise agreed, the route and mode of shipment are left at our discretion.  
At customer's request the goods shall be insured. The risk shall be transferred to the customer upon despatch.  
If shipment is delayed at the customer's request or for a reason attributable to it, the goods shall be stored at the customer's expense and risk. In such case, the notice that the goods are ready for despatch shall rank as despatch.
8. The goods are shipped ex-works at the recipient's risk. Any complaints concerning transport damage must be made upon receipt.
9. **Prices and payment**  
Unless otherwise agreed, payment shall be remitted within 30 days from invoice date so that the sum agreed as settlement of the invoice is at our disposal not later than the due date.  
Only if an according agreement exists, a discount able, properly taxed bill of change shall be accepted for mode of payment.  
Cheques and drafts are credited under the premise of being honored, costs being deducted, and payment shall be considered duly received on the day the amount is actually at our disposal.
10. In the event of late payment, interest on defaulted payment is charged at 4% above the Main refinancing operations Minimum bid rate of the ECB, without a special reminder being required.
11. **Retention of title**  
We retain the title of the goods until full payment of the purchase price. In the case of goods sold by the customer as part of its business activities, we retain the title until all claims upon the customer deriving from the business relationship have been settled. This shall apply even if some or all of the claims have been entered in a current account and the balance has been drawn up and acknowledged. If substantial contractual obligations are infringed and especially in the event of delayed payment, we may take back the goods after issuing a reminder and the customer shall be obliged to deliver them up.  
Unless the German Hire Purchase Law applies, our taking-back or imposition of attachment shall imply withdrawal from the contract only if we have expressly stated this in writing.  
In the event of attachment or other impairments of rights by third parties, the customer shall inform us in writing, sending a record of attachment and an affirmed and signed statement identifying the attached items.  
The customer may resell the goods in the normal course of business and he assigns to us hereby the claim deriving from the resale together with all ancillary claims which he acquires upon his customer or third parties as a consequence of the resale. The customer is authorised to collect the debt, even after the assignment. Our right to collect the debt ourselves remains unimpaired thereby but we undertake not to collect the debts as long as the customer duly fulfills his payment obligations.  
We may require the customer to inform us of the assigned claims and of the parties owing them, to provide all information required to collect them, to deliver up the pertinent documents and advise the debtors of the assignment.  
We undertake to release the security held by us in as much as the value thereof exceeds the secured claims by more than 20 %, in so far as they may not yet have been settled.
12. **Liability for Defects and Warranty Claims**  
Minor defects shall neither constitute a right on the Customer's part to refuse acceptance nor justify any warranty claims.  
We accept liability for defects subject to the following conditions:
  - (1) The delivery items in question found to be defective within the warranty period, provided that such defects can be established to have existed at the time of passage of risk, shall either be repaired or a substitute delivery shall be made free of charge respectively at our discretion.
  - (2) All warranty claims shall become statute-barred after 12 months. This shall not apply where the German laws pursuant to § 438 Para. 1 No. 2 (structures and objects for structures), § 479 Para. 1 (right of recourse) and § 634a Para. 1 No. 2 (building defects) of the German Civil Code (BGB) dictate longer periods of limitation, nor in the case of any loss of life, bodily injury or health impairment, in the case of any wilful or grossly negligent breach of duty on the part of the Supplier and in the event of fraudulent concealment of a defect. This shall not affect the statutory provisions concerning the suspension of expiration of prescription, suspension of the running of the statute of limitation.
  - (3) Following the timely service of a notice of defects, we shall be granted the opportunity for subsequent performance within a reasonable period of time. Should such subsequent performance prove to be a failure, the Customer may – irrespective of his right to claim for damages pursuant to Para. 15) – rescind the Contract or effect a price reduction.
  - (4) We shall not accept warranty claims in the case of merely minor deviations from any warranted quality, in the case of any insignificant reduction in serviceability, in the case of natural wear and tear or any damage caused after the passage of risk to the Customer by incorrect or negligent handling, excessive use, unsuitable operating fuels or materials, or due to defective building works, unsuitable building sites or caused by external influences which were not been taken into account in the Contract, nor damage due to non-reproducible software faults. In the event that the Customer or any third party make any unauthorised changes or carry out any unauthorised repairs, we shall not accept liability for any such changes or repairs nor for any consequential faults.
  - (5) The Customer shall only have a right of recourse against us pursuant to § 478 of the German Civil Code (contractor's right of recourse) in so far as the Customer has made no agreements with his customers extending beyond the limits of the statutory warranty claims.
  - (6) In all other respects, Para. 15) hereunder shall apply to the Customer's right to claim for damages. All other claims by the Customer against us and our vicarious agents or claims other than those covered by this section shall be excluded.
13. We reserve the right to deviate from the illustrations in the catalogue in order to enhance our products.
14. **Impossibility, Adaptation of Contract**
  - (1) To the extent that a delivery is deemed impossible, the Customer shall have the right to claim for damages, unless such impossibility is beyond our control. However, any claim for damages by the Customer shall be limited to 10 % of the value of such part of the delivery item which could not be put into expedient operation as a result of the impossibility. This limitation shall not apply in case of any mandatory liability as in the case of wilful intent and gross negligence or in the case of any loss of life, bodily injury or health impairment. This is not associated with any changes to the burden of proof to the detriment of the Customer and shall not affect the Customer's right to rescission.
  - (2) In the event of any unforeseeable events, such as mobilisation, war, riot or any other similar events, such as strike action and lock-out, should substantially change the economic value or the contents of the delivery item or should such events have a considerable impact on our business operations, the Contract shall be appropriately adapted, bearing in mind the requirements of good faith. If this is not practicable for economic reasons, we shall have the right to withdraw from the Contract.
15. **Other Claims for Damages**
  - (1) All other claims for damages or compensation claims on the part of the Customer (hereinafter: claims for damages), irrespective of the legal grounds on which they may be based, in particular, claims based on any breach of duty arising out of the relationship under the law of obligations and any tortious acts, shall be excluded.
  - (2) This shall not apply in the case of any mandatory liability, for example under the Product Liability Act, in the event of wilful intent or gross negligence, in the case of any loss of life, bodily injury or health impairment or in the case any breach of any essential contractual duties. Any claim for damages based on a breach of an essential contractual duty, however, shall be limited to foreseeable damage or losses as are typical for contracts such as the one between the Contracting Parties, except in the event of wilful intent or gross negligence or in the case of mandatory liability following a loss of life, bodily injury or health impairment. This is not associated with any changes to the burden of proof to the detriment of the Customer.
  - (3) To the extent that the Customer is entitled to claim for damages pursuant to this section 15), all such claims shall become statute-barred upon expiration of the statute of limitation applicable to warranty claims pursuant to Para. 14) above.
  - (4) Damage claims under the Product Liability Act shall be subject to the statutory limitation rules.
16. **Place of Performance, Jurisdiction, Applicable Law**  
The place of performance and exclusive place of jurisdiction for all deliveries and payments (incl. legal action based on dishonoured cheques or bills of exchange), as well as all disputes arising between the Parties shall be Dornstetten, Germany, in so far as the Customer is a registered trader, a legal entity under public-law or a state-operated special fund. All contractual relations between the Contracting Parties shall be governed solely by the laws of the Federal Republic of Germany, excluding the Hague Convention relating to the Uniform Law on the International Sale of Goods.



Precise surveying and measuring

**Nedo** GmbH & Co. KG

Hochgerichtstrasse 39-43  
D-72280 Dornstetten  
Germany

Phone +49 (0) 7443 24 01-0  
Fax +49 (0) 7443 24 01-45

[info@nedo.com](mailto:info@nedo.com)  
[www.nedo.com](http://www.nedo.com)